

Operation Manual

EN

GP3300HD



Engine driven



Translation of the original operation manual

*The picture serves for reference only and it may not represent an exact match of the device delivered

INDEX

Application compliant with the product design	p. 1
Environmental protection	p. 1
Safety	p. 1
Scope of delivery	p. 2
Assembly	p. 2
Commissioning	p. 3
Engine	p. 4
Engine maintenance	p. 5
Pump	p. 7
Troubleshooting	p. 9
Warranty	p. 10
Technical data	p. 10
Declaration of conformity in compliance with EU standards	p. 12



CAUTION

Please read this operation manual carefully before the first use of your device and pay attention to the safety instructions attached. Please obey these instructions at all times. Keep the operation manual for potential future use or the next owner of the device.

Application compliant with the product design

The use of this high-pressure washer is limited to:

- in homes and businesses where the machine running time does not exceed 5 hours per week.
- washing of machinery, vehicles, structures, tools, facades, gardening tools, etc. combined with a high-pressure water supply (with added cleaning agents, wherever required);
- operation with accessories using spare parts approved by WPW Center s.r.o.
- In an environment where the device will not be exposed to direct splashing of contaminated water with solid particles.

Environmental protection



The packaging materials are recyclable. Packaging disposal methods must comply with the environment-friendly principles.

Used machines contain valuable and recyclable materials that can be reused. Any disposal of used machinery must be conducted in environment-friendly manner.

Any cleaning works producing waste water contaminated with oil, e.g. cleaning of engines or floors of machinery, may be only performed in cleaning facilities provided with oil separating equipment. Works with cleaning agents are limited to working areas with proper sealing to prevent leakage of fluids and linkage to the contaminated water sewers. Make sure to avoid leakage of cleaning agents into water resources or soil.

Safety

Safety Instructions

Make sure you read the "Safety Instructions for High-Pressure Washers" in full prior to the first use of this device. Noise reduction tools and protective glasses should be used for the convenience of operators for

hearing and eye protection purposes during operation of the cleaner.



Hazard levels

 **DANGER** - Indication of an immediate danger potentially resulting in serious injuries or death.

 **CAUTION** - Indication of a potential hazardous situation that may result in light injuries.

 **WARNING** - Indication of a potential hazardous situation that may result in material damage.

Safety features

 **CAUTION** - Safety features are designed to protect their users from injuries and these may not be altered in any way or even put out of order. Any damaged items must be replaced with original spare parts only.

Protective guards on hot or rotating parts



The protective guards are designed for protection of operators using the high-pressure washer to avoid injuries caused by temperatures of certain components of the combustion engine or injuries caused by rotating parts of the device.

Safety features on the combustion engine and pump

The engine oil level safety switch (if fitted) serves for automatic deactivation of the engine in case the engine oil level drops below the minimum threshold. That will prevent damage to the engine due to insufficient lubrication of internal parts. However, this safety features does not substitute the need to check the engine oil level prior to use of the device.

For further important information see the section – ENGINE (p. 4).

The pump safety valve serves for drainage of some hot water developed during internal circulation of water inside the pump during operation without discharge of the high-pressure water.

Once the safety valve opens automatically, some of the hot water pours out of the pump to be replaced with cold water from the connected supply. However, this safety feature does not substitute the need to switch the pump off when not in use for periods exceeds 2 minutes. For further important information see the section – PUMP (p. 7).

Scope of delivery

For depiction of delivery contents see the packaging or the purchase order. Check the contents completeness when unpacking. Any items missing or any damages incurred in transport should be notified to the seller.

Additional items required

Fabric-reinforced water hose with the diameter of ½" (13 mm) with a regular garden quick-coupler. The supply hose must be at least 5 m and at most 15 m long. The device must be linked to an adequate water resource with the minimum delivery pressure of 1 bar and the flow rate of 14 l/min.

Assembly

The device itself is assembled in the manufacturing plant. Fix the upper frame section - grip - onto the bottom part, by sliding it onto the narrowed part of the tube and use the flexible metal spring to lock it in place. (Figure on page 3). Before connecting the hoses, remove the covers from the high-pressure water outlet and inlet on the pump. The first operation requires connection of the high-pressure hose, included in the delivery, with the control gun and nozzle to the high-pressure section of the pump.

The next step requires filling of the supplied oil into the engine, as directed by instructions in the section **ENGINE** (p. 4) and filling the tank with fresh petrol with octane rating of 95.

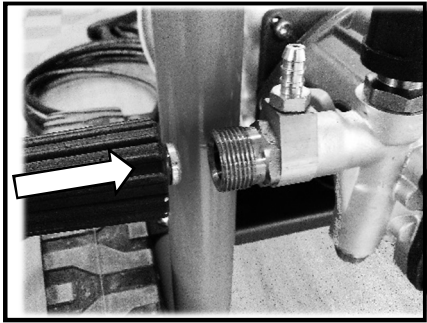

Standard without self-suction

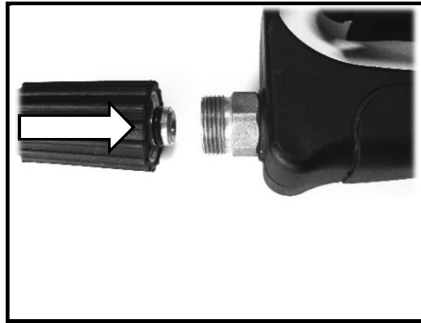

Self-suction version up to -120cm

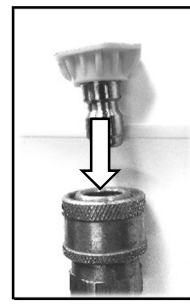
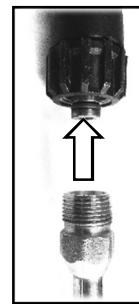
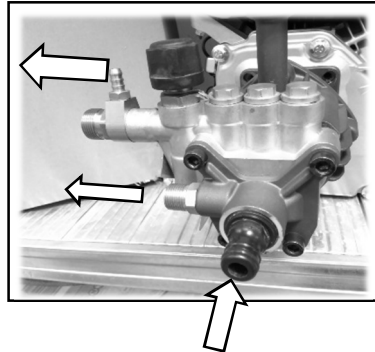
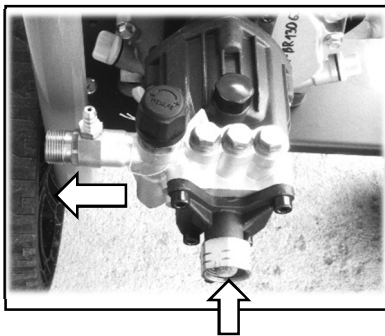
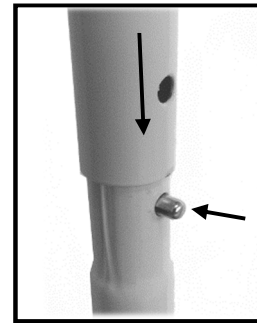

The low-pressure inlet on the pump must be fitted with the garden hose adaptor, included in the delivery.

Commissioning

Water supply

CAUTION Avoid operating the pump without a water supply line connected and fed from the source. The water resource yield must correspond with at least 14 litres per minute, at the minimum pressure of 1 bar. If the purity of supplied water cannot be guaranteed, the system needs a water filter placed before the pump inlet to avoid influx of solid contaminants inside the pump.

Having connected the hoses, open the water tap fully to its limit position and depress the control lever on the high-pressure gun. To deaerate the pump hoses, keep the gun in depressed position until you observe an even flow of water out of the quick-coupler. Insert the adaptor quick-coupler with the high-pressure nozzle. **If the pump has not developed pressure within 30 seconds following its commissioning, switch the engine off and proceed in compliance with instructions defined in the Troubleshooting section! Any dry cycling of the pump for a period exceeding 30 seconds may result in damage!**

Any material damage caused due to inobservance of this instruction renders the warranty void.

CAUTION WHEN USING SELF-PRIMING FUNCTION

For pumps provided with the **SELF-SUCTION**: The high-pressure cleaning equipment is provided with a jacket hose and flange from the WPW Center company (special accessories, catalogue number SP000-HI001+RKD02-3025G1) can be used for removal of surface water, e.g. from storm water reservoirs. The water in reservoir must be clean, free of any contaminants or sludge. Contaminated water causes irreversible damage to internal components of the high-pressure pump. Connect the hose to the filler neck directly. Make sure the sealing between the hose and the pump neck is free of any damage. Submerge the other end into the water reservoir. Remove the nozzle from the quick-release end of the high-pressure gun attachment so that the water spills out freely when the trigger is depressed. Start the engine and depress the gun control lever to let the water flow out freely, until the stream comes out free of any air bubbles. The time required to pump water up to a continuous flow is proportional to the length of the inlet hose and the height of the pump in comparison to the water level. The longer the hose and the greater the height difference, the longer the time it takes to pump the liquid. The maximum height difference is 120cm. Once the system has been bled, fit the nozzle and restart the engine again. The pump is ready for operation now. If the pump has not developed pressure with the engine running for 30 seconds, switch the engine off and proceed in accordance with instructions defined in the Troubleshooting section.

CAUTION: When air gets into the pump, it's necessary to remove the leaks and repeat the whole process of bleeding the pump.

Engine



Oil plug with gauge

The engine **MUST** be filled with the correct amount of engine oil supplied with the delivery before its first commissioning. The bottle with engine oil **may contain larger amount** than required for the particular engine type. For specifics refer to the Technical data section. For easier cold engine start, we recommend reducing the water outlet pressure according to the instructions on page 8. Set the pump on a horizontal surface. Open the oil sump plug, also fitted with the oil gauge. Fill the engine with approximately $\frac{3}{4}$ of the oil amount required. Screw the plug back into the oil sump. With the **C** switch set to the **OFF (0)** position (see the figure below), cycle the engine by pulling the starter cord. Remove the plug, wipe the gauge dry and check the engine oil level.

CAUTION: To get the correct reading, the gauge must be fully screwed in place. Top up the oil to achieve the final level between the MIN and MAX marks.

Remove the plug and fill the tank with petrol carefully. To ensure full performance of the engine, use fresh petrol with the octane rating of 91 or higher. The physical properties of old and vapid petrol are different and it may cause an uneven run of the engine or reduced pump performance. **Use clean and oil-free petrol only - your engine is a four-stroke type.**



DANGER

When in operation, the engine produces carbon monoxide,



which is a colourless and odourless poisonous gas. Inhalation of carbon monoxide may cause nausea, headaches, dizziness, vomiting or even death! The device may be used outdoors only, with proper ventilation ensured. It is also necessary to prevent ingress of exhaust gases into enclosed rooms via unsealed openings. When working with the engine on, turn the device in such direction, where the exhaust does not remain pointed at persons standing in the vicinity or any opening in nearby structures (garages, galleries, cellars, etc.). When in operation, the engine produces waste heat, resulting in heat-up of various engine components (exhaust, engine cylinder), which may cause serious burns. These components may cause fire, when in contact with flammable materials.



DANGER



Petrol fumes are extremely flammable and explosive substances that may cause burns, fire or even explosion, when handled improperly. Let the engine cool down for 5 minutes before adding petrol into the tank. Then proceed with careful removal of the tank lid and start pouring the petrol in with caution. NEVER fill the fuel up to the rim, since petrol warms up during engine operation and swells, which may result in leakage through the lid and subsequent explosion of fire. NEVER tip the high-pressure device into such position, where petrol may leak from the tank. NEVER attempt to start the engine with damaged components in the fuel supply, ignition or safety features.

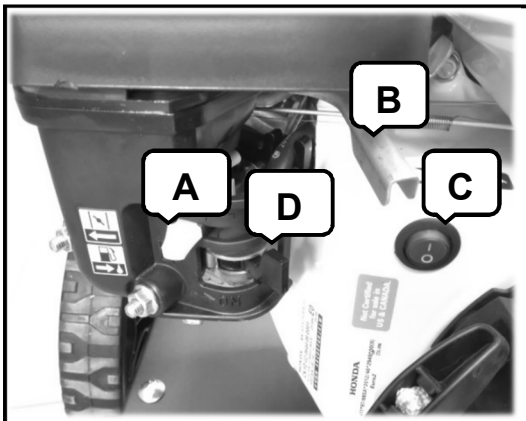

Turn the engine switch **C** and the fuel switch **D** into the **ON (I)** position.

Shift the speed control lever **B** into the  position.

Shift the choke control lever **A** into the **CHOKE** position.

Grasp the pump grip with one hand firmly and use the other hand to hold the starter cord grip.

Pull the starter cord to the point, where you feel resistance from the engine. Then pull the grip sharply to prevent recoil. If the engine fails to start on the first attempt, depress the gun and relieve the water pressure in a safe direction. Then repeat the starting process by pull the starter grip again.

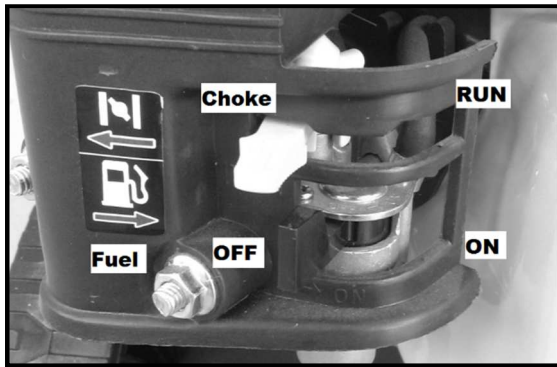

CAUTION! The starter cord recoil (engine resistance against the direction of starter cord pull) will draw your shoulder and hand towards the engine faster than you are able to release is, this may result in spraining, contusion or breakage of your limb.

Once the engine has started up, shift the choke control lever **A** into the **RUN** position **SLOWLY**.

ENGINE SHUTDOWN

Engine shutdown comprises the following steps

Shift the engine speed control lever (page 4) **B** to ½ of the turn towards the position  and let the engine run for at reduced speed for 15-20 seconds. Then proceed with turning the engine ignition switch **C** and the fuel switch **D** into the **OFF (0)** position.

CAUTION The motor is not equipped with a sensor that shuts down the motor if the motor oil level drops to dangerous levels. Disregard to the regular inspections may result in irreversible damage to internal components of the engine. Such damage is not covered by the warranty.

NEVER spray any water on the engine when hot. Such actions may cause ingress of water into the fuel system or the ignition system. Clean the engine with a damp cloth and compressed air to remove dust from the air filter compartment.

MAINTENANCE

Every 8 hours or every day	Engine oil level check Inspection of air filter and exhaust vicinity
After the first 5 hours	Engine oil change
Every 50 hours or at the end of the season	Clean the air filter Engine oil change
Every 100 hours	Inspection and adjustment of the ignition spark plug electrode. Fuel pipeline check

There may be rare cases, when the protective metal guards come loose during operation. These parts need to be tightened, since long-term exposure of a loose guard to vibrations causes damage to the mounting holes. If damaged, the protective guard on the exhaust, the air filter or the cooling fan must be replaced with original spare parts, since that is the only way to ensure maximum operation safety.

Spare parts are available from the manufacturer or any authorised servicing centre. For a complete list of components, see this manual or the manufacturer's website.

Storage for winter season

Correct long-term storage methods are essential to ensure smooth operation during the next season. Correct storage helps extend the engine service life.

The following steps will help you ensure the maximum service life of engine components with protection against corrosion and wear of sliding components of the engine.

The engine must be stationary and its temperature must be below 50°C. Use a damp cloth to clean the engine from dust and dirt. Once dried up, any potential damaged spots must be treated with paint or a piece of cloth soaked up with oil. That will prevent entry of air to the metal sheet and subsequent corrosion.

Open the fuel tank cap and check the quantity of fuel inside the tank. Long-term presence of fuel inside the tank during storage has an adverse effect on the fuel quality. That may cause an uneven operation of the engine and a reduced performance. Using the drain plug located on the bottom side of the carburettor, drain all petrol from the tank and the carburettor. **DO NOT TIP THE ENGINE OVER.**

THERE IS AN OIL LEAKAGE HAZARD! It is recommended to change the engine oil at the end of the season. That will extend the engine service life.

Engine oil change

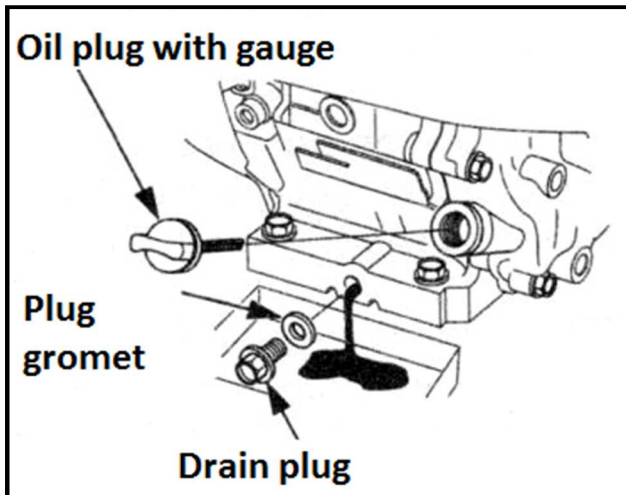

It is recommended to change the engine oil after use of this equipment (according to the Maintenance Schedule). Switch the engine off. Let the device cool down for a while, so its temperature drops below 50°C. This will prevent potential burns. The engine should remain warm still. Warm oil drains from the engine more easily.

- Unscrew the OIL PLUG WITH GAUGE.
- Place a container with the minimum capacity of 1 litre below the drain plug.
- Loosen the drain plug carefully.
- Let the oil drain smoothly into the prepared container.
- Once the oil stopped draining, tip the engine to the side

slightly to let the remaining oil out too.

- Clean the surroundings of the drain plug and re-tighten the drain plug in its place again.



- Used engine oil needs to be deposited at one of the authorised collection points. **Engine oil is hazardous waste!**

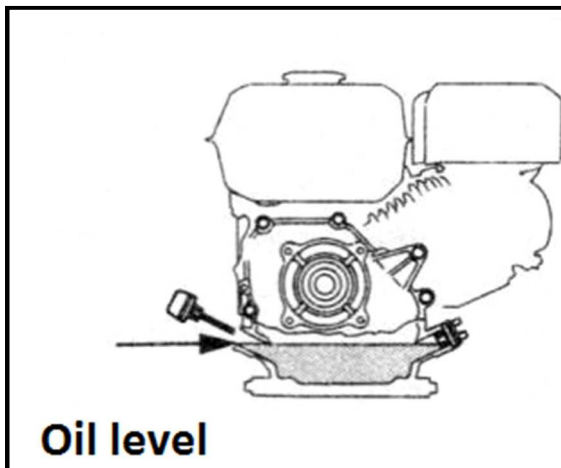

Fill the engine with the correct amount and type of engine oil. For engine oil specifications, see below.

- For specific filling volumes refer to the Technical data section.

- Set the pump on a horizontal surface.

Fill the engine with approximately $\frac{3}{4}$ of the oil amount required. Screw the plug back into the oil sump. With the engine operation switch in the **OFF (0)** position, cycle the engine by pulling the starter cord. Remove the plug, wipe the gauge dry and check the engine oil level.

CAUTION: To get the correct reading, the gauge must be fully screwed in place. Top up the oil to achieve the final level between the MIN and MAX marks.

Engine oil specifications

Engine oil is one of the factors influencing the performance and service life of the engine.

The minimum requirements for engine oil are: Viscous grade 10W30 or 10W40 with the quality rating of SF or higher (SG, SH, SJ).

Use of engine oil grade 10W30 at ambient temperatures exceeding 27°C may result in higher oil consumption. The engine oil level therefore requires more attention, when operating the device at such ambient temperatures using the engine oil grade 10W30. It is recommended to use oil grade 10W40 with the quality rating of SF or higher (SG, SH, SJ).

The engine oil included in the delivery exceeds the minimum quality requirements highly and it will ensure safe operation of the engine with minimum wear of their internal components under demanding operating conditions.

When topping up the engine oil, use the type and brand of oil already matching the existing filling. Mixing of different oil types is not recommended!

Pump

Your pump features an all-metal frame to ensure its long service life and flawless operation. The pump contains rotating parts mounted in very precise housings. It is therefore INEVITABLE that water fed into pump remains free of any mechanical contaminants. These contaminants would grind the contact surfaces inside the pump to increase the play between its internal components and reduce the output pressure.



DANGER

The pump generates a very high pressure at the outlet, making



the outlet water jet destructive to soft items. **IT IS PROHIBITED to point the water stream at humans or animals. Disrespect to this warning may result in devastating effects leading to permanent blindness, incised wounds, amputation or even death.**



CAUTION

High pressure may cause damage to soft and sensitive objects. It is not recommended to use a high-pressure jet in a close proximity to clean rubber or tires, glass, cohesion less varnish, plasters or wood. Too strong water jet may alter the surface texture and result in permanent change of surface finishes. In case of any doubts, it is recommended to test the effect of pressurised water jet on a sample, where the potential alteration of surface texture has no impact on the operability or appearance of the particular object.

Setting the jet further from the surface of object being washed will reduce the pressure generated by water impact and alleviate the aggressive washing effect. On the other hand, proximity of the jet to the surface will increase the washing performance of water on the particular surface.

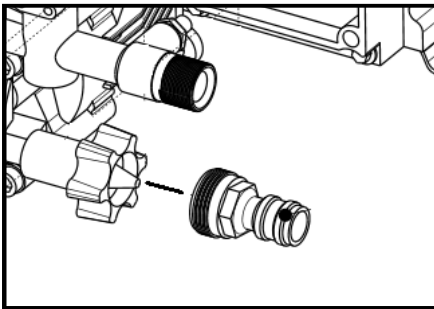

The water inlet neck is provided with a safety screen. The screen requires regular inspections with respect to potential contamination or damage. Deposited contaminants will reduce the flow of water supplied, further resulting in reduced washing performance.

The screen must be replaced with a new one IMMEDIATELY, when damaged.

Mechanical damage of internal components of the pump due to water contamination is not covered by the warranty!

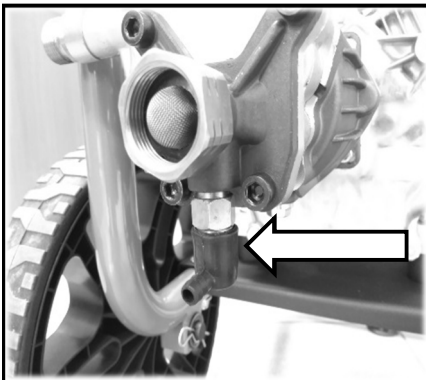

The check valve serves for draining of a small volume of hot water from the pump without any intervention by its operator in order to protect the pump from overheating. There is no overheating hazard during regular operation, since the pump is fed with a constant supply of cold water to ensure its cooling at the same time. The process of excessive heat-up starts, while the engine is still on and the high-pressure gun is off and there is no water jet coming out of the nozzle. The pump will switch to the internal water circulation mode automatically. The constant circulation of water continues, until the temperature has reached the point for check valve to drain a small amount of hot water in order to ensure infeed of cold water to cool the pump down. That is why **the temperature of water fed into the pump is limited to 40°C only**. If the pressure washer is to remain idle for more than a few minutes, it should be

switched off to prevent excessive load on the check valve and pump. If the collecting pipes from the RKD002-3025G1 accessory are used, the pump can run without releasing the pressurised water for a longer time as it's cooled by the external circulation of water through the vent pipes.

When using the self-priming water supply mechanism:

Make sure the water inside the supply contained is placed as high as possible, when compared to the water supply into the pump. Higher elevation difference of water levels helps to simplify the priming and reduce cavitation - the phenomenon associated with release of air bubbles from the liquid. That may happen inside the pump, if the vacuum at the inlet is too high - impaired priming. There is a risk of damage to the pump.

That is why the priming hose should have the largest diameter possible and it must be the shortest possible. Follow the methods defined on page 3 to bleed to priming pipe.

Preparing the pump for operation

The pump is filled with operating oil. Due to the changes in oil temperature during operation and thermal expansion, a DISCHARGE VALVE is located on the upper side of the container. In order to avoid oil leaking from the pump during transport, the valve opening is closed by a transport plug. **BEFORE FIRST USE, IT'S NECESSARY TO REPLACE THE PLUG FOR BLACK VENT PLUG (A) WITH RED RING!**

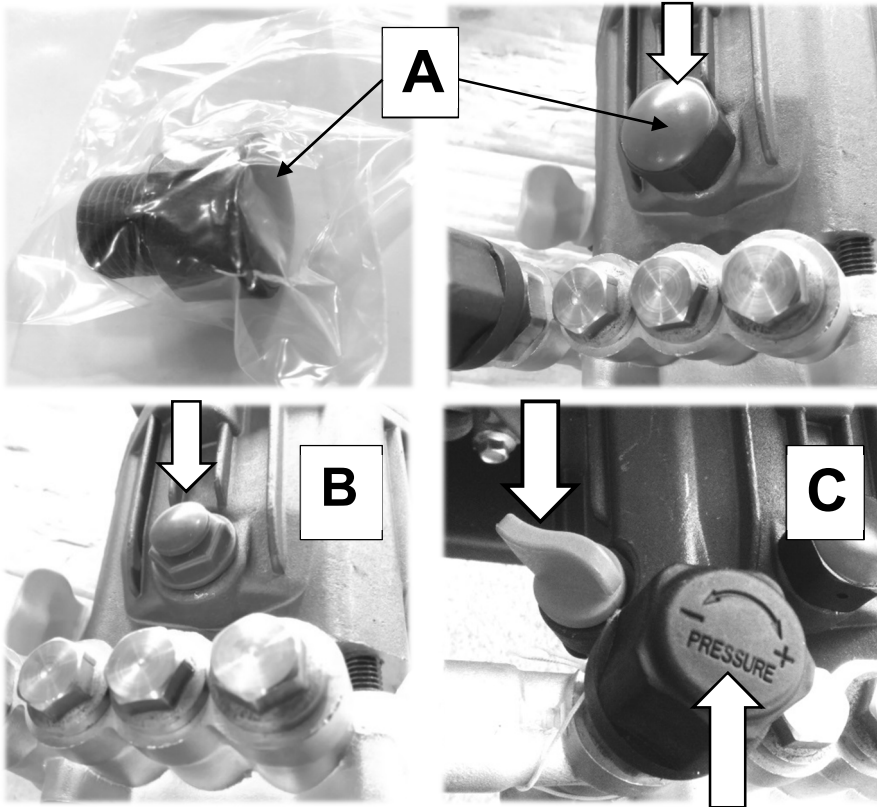

Figure A shows the pump's vent plug, which should be screwed onto the red transport plug (B) located on top of the pump housing. The transport plug is only for transport **and the device must not be used without replacing it with the vent plug!**

Replace the red plug with a black plug (located in the bag attached to the pump) before using it the first time. **Safety data:** The pump is filled with 15W40 class SF oil at an amount of 100ml. Before starting, it is necessary to check the oil level in the pump gauge (Figure C). To check the oil level, place the pump in a horizontal position. Otherwise it will not match the level of the recorded facts. The oil level must be within the required range during operation to

ensure complete lubrication of the internal components. Unscrew the plug and check the level. It must be between the slots on the stem scale. Risk of permanent damage to the device! The operation of a pump with a low oil level or without oil filling will cause permanent damage to the pump and void the warranty. Check the oil level before each use! **If it is necessary to add oil in the pump, use only oil class: 15w40 SF-SJ. Do not exceed the maximum oil level! This can result in damage to the shaft seals and oil leakage from the pump.** Running the pump without water or when it's dry causes permanent damage to the pump and voids the warranty. Check the water inlet before each use! Due to optimum lubrication, the pump must be at a maximum incline of 15° from the horizontal plane.

Regulation of output water pressure

This pump allows the water outlet pressure to be controlled in the range of 80 bar to 220 bar. To change the pressure, it is necessary to turn the controller located on the pump (Figure C - Pressure). The rule is: looking from above and turning TO THE RIGHT (clockwise), the pressure increases and turning TO THE LEFT reduces the pressure. Increasing the pressure increases the load on the motor and fuel consumption as well. That is why it is suitable to adjust the water pressure according to the specific situation. Reduce the pressure to extend the service life of the motor and pump.

Pump maintenance

The oil in the pump is replaced after the first 30 hours of operation and every subsequent 100 hours of operation. Use 15w40 SF-SJ oil class for the change. Drain the oil from the pump by releasing the plug located on the bottom side of the pump. It is advisable to replace the oil after use when the oil is warm, when it's easier to drain and impurities are dispersed in oil. After draining the old oil, screw the drain screw back slowly, pour the oil slowly through the opening of the vent plug and at the same time check the oil level located on the side of the pump. Take care that the oil flows slowly inside the pump, it can easily overflow. After reaching the required oil level screw the vent plug and oil stopper back into the pump cover.

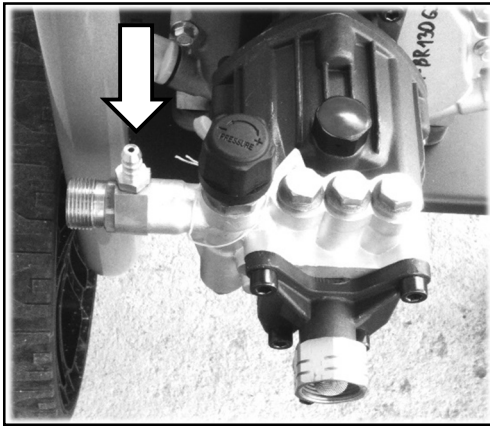

Use of self-priming detergent

The pump has the ability to automatically inject the detergent with pressure from the container. A black nozzle for the application of detergent is required to run this function (cat. number: ASBS0-N0065). Only with the use of the nozzle, the pump starts to inject the detergent itself through the hole indicated by the arrow. Connect the supplied detergent tube to the place mark with an arrow (near the pump high-pressure end) and immerse the other end with the suction sieve into the diluted detergent container. Apply the detergent by pressing the gun trigger. **This configuration doesn't serve to create active foam.** In order to create active foam, it's necessary to buy an aerator (cat. number: SP000-FL002).

Pump storage for winter season

Storing the pump in areas with the ambient temperature below the freezing point may result in irreversible damage to internal components, if not drained properly!

Excess water draining procedure:

Make sure the engine switch (p. 4 pos. C) is in the **OFF (0) position.**

Disconnect the supply hoses from the pump. Grasp the starter cord grip and pull the cord **5 times**, as if you were starting the engine. This action will help the water drain out of the pump through the high-pressure opening. It is not recommended to store the pump in areas with the ambient temperature dropping below the freezing point, since a significant change of outside temperature may result in condensation of water vapour even in areas regularly not affected by water ingress. That may result in internal corrosion and a more significant reduction of the service life of pump and engine.

Troubleshooting

Problem	Cause	Remedy
The pump fails to generate sufficient water pressure, the water jet is intermittent and the water flow is low	<ol style="list-style-type: none"> 1.Nozzle with a large opening used 2.Blocked water supply 3.Low volume of water supply 4.Clogged screen on water supply line 5.Clogged or leaking high-pressure hose 6.Supply water temperature too high 7.Water pressure leakage from the gun 8.Clogged nozzle 9.Damaged pump 10. Improper priming of pump during the self-priming mode 	<ol style="list-style-type: none"> 1.Replace it with a nozzle of the correct size 2.Check free water flow 3.Use a higher water pressure or a hose of larger diameter 4.Clean the screen or replace it with a new one 5.Remove contaminants, turn the hose around, flush it or replace it with a new hose 6.Procure a supply of colder water 7.Check the connections for tightness, replace the gun 8.Clean the nozzle with a steel wire and flush it with flowing water 9.Contact a servicing centre 10. Check all the connections on the inlet side for tightness, prime the pump as instructed (page 4)
The pump fails to draw the cleaning agent	<ol style="list-style-type: none"> 1.Wrong nozzle used 2.The priming hose is not dipped in the cleaning agent or it is clogged 3.Clogged hose or strainer 	<ol style="list-style-type: none"> 1.Replace the high-pressure nozzle with a low-pressure (black) one 2.Check the volume of cleaning agent and adjust the position of hose 3.Clean the washer with flowing water, replace the priming hose
The engine runs smoothly when not loaded, jerky under load	<ol style="list-style-type: none"> 1.Low engine speed 2. Water pressure too high 	<ol style="list-style-type: none"> 1. Adjust the position of speed control lever, check the position of locking screw for engine speed control 2. Reduce the water outlet pressure by the pump controller as described on page 8.
The engine stopped during operation	<ol style="list-style-type: none"> 1.The engine has run out of fuel 2.The spark plug terminal has fallen out 3. Low oil level in the engine 	<ol style="list-style-type: none"> 1.Add fuel into the tank 2.Check the spark plug terminal 3. Check the engine oil level

The engine fails to start or starts and runs in jerky way	<ol style="list-style-type: none"> 1.Clogged air filter 2.The engine has run out of fuel 3.Old fuel 4.The spark plug terminal is not linked with the spark plug 5.Faulty spark plug 6.Fuel contaminated with water 7.Incorrect fuel mixing rate 	<ol style="list-style-type: none"> 1.Clean the air filter 2.Add fuel into the tank 3.Replace the fuel with fresh one or even top up a larger amount of fresh fuel 4.Check the fittings of terminal on the spark plug 5.Replace the spark plug with a new one 6.Drain the fuel from tank and carburettor and add fresh fuel 7.Contact a servicing centre
Insufficient engine performance	<ol style="list-style-type: none"> 1.Clogged air filter 2.Old fuel 	<ol style="list-style-type: none"> 1.Clean the air filter 2.Fill the tank with a fresh fuel

Use original parts only. That will ensure smooth operation of your device.

Warranty

The warranty conditions of our distribution organisation apply in every country. Potential failures of your devices will be removed free of charge within the warranty period, if due to defects of material or workmanship. To claim the warranty, please submit the sales receipt for your device at your distributor or the closest authorised servicing workshop. For the list of approved servicing centres, see our website at: www.waspper.com

The efforts made by WPW Center s.r.o. are aimed at sustainable development of technical parameters and user-friendly parameters of its products. For this reason, the manufacturer reserves the right to alter the design and control features without any prior notification to the end customers. The position of all control and safety features illustrated in this manual corresponds with their actual positioning. This manual does not have to reflect any changes in design of control levers.

Technical data

Device type	GP3300HD		
Engine type	Honda 196cm ³ / 4,1kw		
Maximum speed	3600 rpm		
Engine model	Four-stroke OHV		
Torque	12,4 Nm/ 2500 rpm		
Ignition spark plug	Brisk: LR15YC spacing 0.7-0.8 mm		
	Champion: RN7YC		
	NGK: BPR6ES		
Fuel tank capacity	3.1 l		
Oil filling capacity	0.6 l / 10w40		
Water pressure and flow	3200psi/ 220bar 11 l/ min.		
Net weight	27.5 kg		
Height	99 cm		
Width	52cm		
Length	57cm		
Water priming function	No		
Using the accessories RKD02-3025G1	Yes - 120cm		

List of components

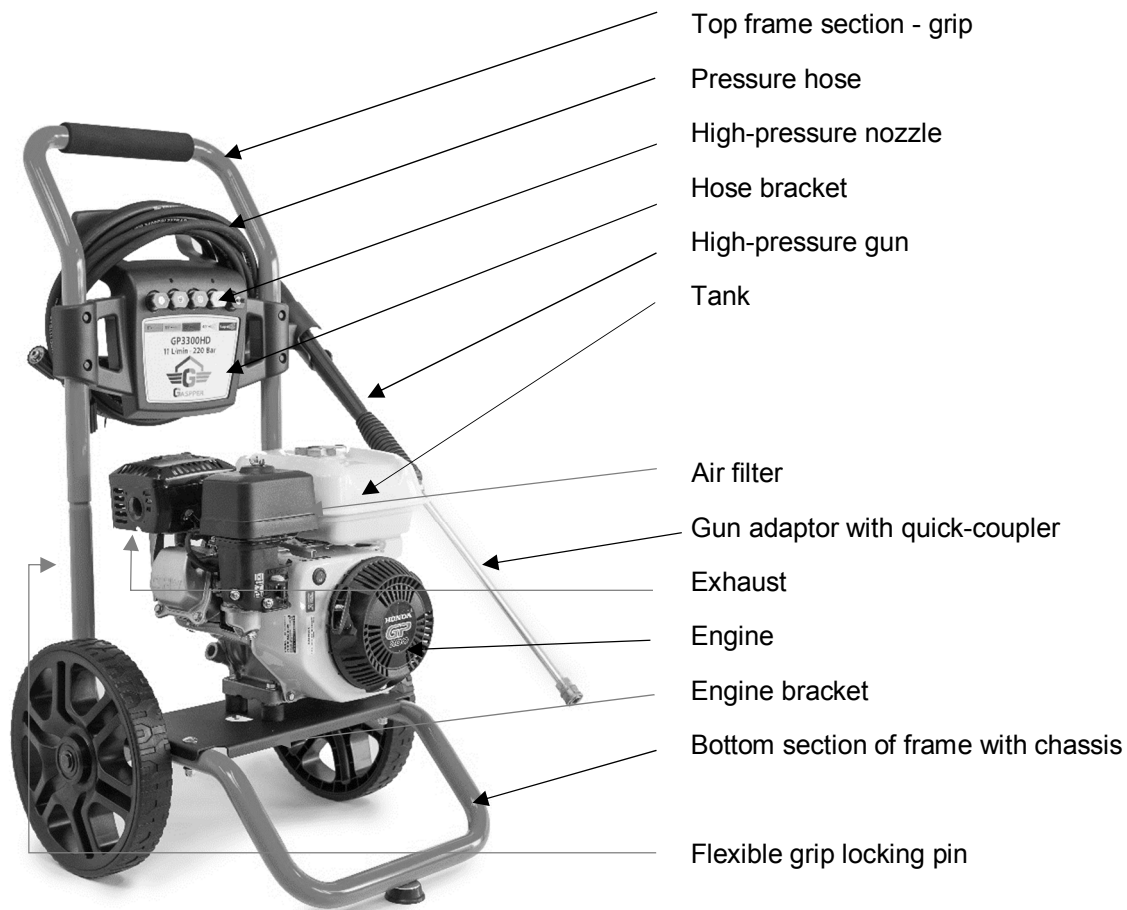



EU Declaration of Conformity

The company WPW Center s.r.o. hereby declares that the high-pressure washers defined below comply with the relevant EU directives on occupational health and safety of the device operators. Any alteration of the device without the prior consent from the manufacturer will render this declaration void.

Product details: High-pressure washer

TYPE	Inspection reports	Noise level measured	Guaranteed noise level
GP3300HD	5057/3/2017	103dB	105dB

Certificate issued by: TECHNICKÁ INŠPEKCIA a.s., the KOŠICE workplace as an accredited inspection body in accordance with EN ISO / IEC 17020 standard

Applicable EU Directives:
2006/42/ES (+2009/127/ES)
2004/108/ES
2000/14/ES

Standards applied:

STN EN ISO/IEC 17 020

Producer:

WPW Center s.r.o., Radlinského 20, 05201 Spišská Nová Ves, Slovensko

Issued in: Spišská Nová Ves

Manufacturer's representative: Dobroslava Šupolová

Issue date: 10.10.2017

Position: Managing Director

Warranty Certificate

Product type:	WASPPER	Stamp and signature:
Serial number:	Date of purchase:	

In pursuit of service enhancement and simplification of communication with customers, the company WPW Center s.r.o. recommends its customers, who purchase this product, to register their product via the manufacturer's website: www.waspper.com. This registration will provide inevitable data for faster processing of your complaints or consulting relevant to purchasing of spare parts and accessories. This registration enables the customer to avoid further procedures, as submitting of the purchase receipt or the warranty certificate.

1. The manufacturer - WPW Center s.r.o. - is liable for inherent defects of the product purchased, if such defects become evident within the warranty period. Application of claims for repairs under warranty requires completion and submission of the complaint form via the manufacturer's website: www.waspper.com. The product is covered by a full warranty of 24 months for private customers (as defined by the Civil Code) and 12 months for corporate customers (as defined by the Commercial Code). The warranty period commences upon completion and submission of the complaint report via the website in case of simple defects and damages. The commencement of warranty in case of major defects starts upon the product delivery to the manufacturer's address: WPW Center s.r.o, Radlinského 20, 05201 Spišská Nová Ves. Acceptance of complaint will be notified to the customer using the contact details entered in the complaint form.

2. The warranty does not cover defects incurred due to: wrong operation; improper handling or use contradictory to the operation manual or instructions and recommendations from the company WPW Center s.r.o; use or storage of goods within inappropriate areas, especially with respect to temperature, dust formation or ambient humidity; exposure to direct sunlight; damage attributable to natural disasters of force majeure. The warranty does not apply to mechanical damages, any damages due of solid particles, frost or other weather effects. The warranty does not apply to damage to the pump caused by cavitation. Other exemptions from warranty include damages to the engine due to lack of oil and ingress of any other but operating fluid among internal engine components.

3. Particular steps of claims processing will be notified to the customer following assessment of the scope of repair by the claims engineer. Whenever the replacement of a damaged component can be performed by the customer, the latter will receive a relevant spare part only. If the repair by a servicing centre is inevitable, the customer is obliged to mail the damaged device to the manufacturer's address. The device must be complete (including accessories) and packed properly to prevent its damage during transport, it must be free of mechanical damage and contain no operating fluids. If the goods submitted to the servicing centre shows evident signs of damage or excessive wear, the manufacturer reserves the right to reject such consignment without acceptance.

4. Claims for repairs under warranty oblige the customer to provide the receipt of purchase (invoice, cash receipt) together with the warranty certificate and written description in support of their claim, including photographic documentation. It is recommended to complete the complaint form via the manufacturer's website to ensure the fastest processing of the claim as possible, if the manufacturer acknowledges such claim as justified, the repaired item will be sent to the customer and the postage/freight will be covered by the manufacturer.

5. If the claims engineer finds out the product does not comply qualifications for repair under warranty, the claim will be considered unjustified and the costs of product transport to the customer will be paid by the latter.

6. Should the repair period exceed 30 days or if the product is irreparable, the customer will be offered a replacement item.

7. Justification of claims will be assessed by the claims engineer at the manufacturer. Justified claims will extend the warranty period by the period taken by the claim processing period. Such action will be confirmed to the customer by means of a document in writing, dispatched together with the product or sent via e-mail. If the product subject to claim contains any discontinued component, the manufacturer will provide the customer with an adequate replacement item with its parameters corresponding with the returned product or even better.

8. The customer undertakes to read all the information found on the packaging or in the operation manual; to do so immediately following the product delivery, to acknowledge that preservation of the positive characteristics of the product delivered will be subject to its proper operation and storage. Any disregard to obligations defined herein relieve the company WPW Center s.r.o. from any liability for defects of goods or damages incurred due to breach of this obligation by the customer or any other third party. The customer is obliged to check the intact condition of packaging and product during the purchase and takeover of the consignment from the postman. Any damage to the packaging must be reported to the carrier and recorded immediately. Any damages found only after unpacking of the product must be notified to the distributor within the maximum period of 4 working days. No later claims for product damage can be accepted.

Preparation of the device before the first start!

Check the oil level in the engine

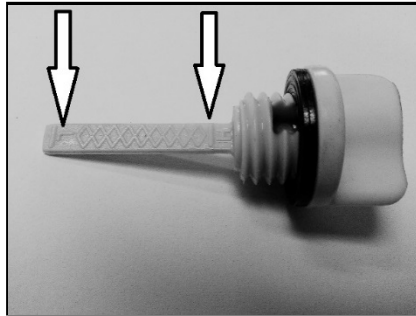
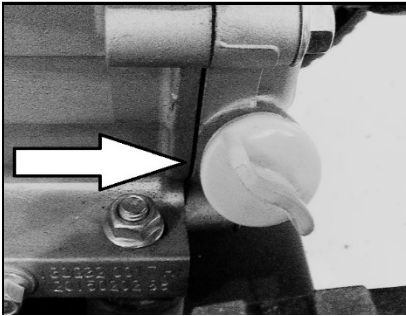

Engine is oil-free from production!

Unscrew the oil plug with a gauge and pour the engine oil supplied with the cleaner. Pour 0.6L oil into the engine. Screw the plug back into the engine. Remove the plug and check whether the level is between the L and H marks.

Preparing the pump for operation

The pump is filled with operating oil. Due to the changes in oil temperature during operation and thermal expansion, a DISCHARGE VALVE is located on the upper side of the container. In order to avoid oil leaking from the pump during transport, the valve opening is closed by a transport plug. **BEFORE FIRST USE, IT'S NECESSARY TO REPLACE THE PLUG FOR BLACK VENT PLUG (A) WITH RED RING!**

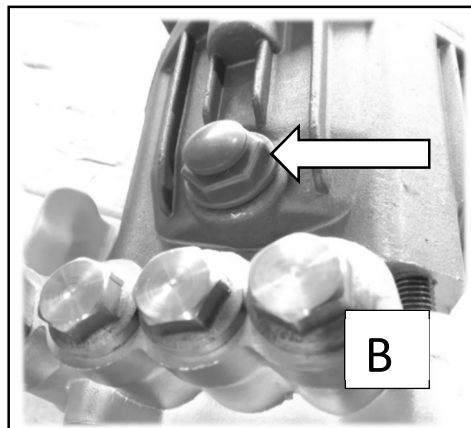
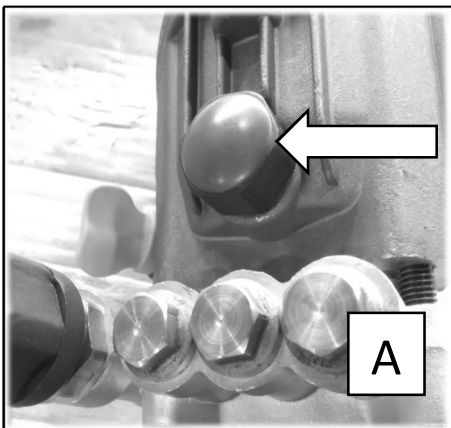
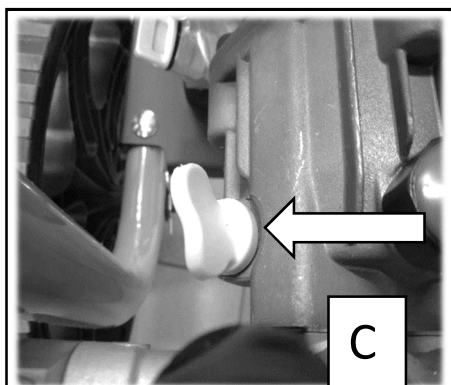
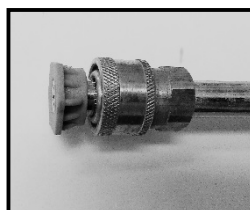
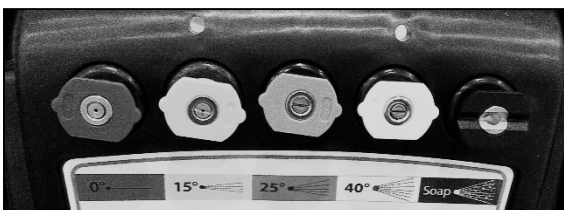

Figure A shows the pump vent plug that must be screwed onto the red transport plug located on the top of the pump housing (figure B). The transport plug serves only for transport purposes and the device **must not be used without replacing it with the vent plug.**



(Figure C) If it's necessary to add oil to the pump, use only the following grades of oil: 15w40 SF-SJ. Do not exceed the maximum oil level! This can result in damage to the shaft seals and oil leakage from the pump. The correct procedure for checking the oil level is given in the section: The Pump.

High pressure nozzle selection



Select the desired Nozzle. The following rule applies: Wider spray angle = larger area of the slide – weaker washing effect. Insert the nozzle into the end of the stainless steel piston rod by pulling the ends outer ring toward the pistol.

