

Instruction Manual

EN

WP20CH/P



Engine driven



Translation of the original operation manual.

* The picture of the device is illustrative and doesn't necessarily correspond to the actual display of the supplied device

TABLE OF CONTENTS

Use of the Product in Accordance with Its Intended Use	Page 1
Environmental Protection	Page 1
Safety	Page 1
Scope of Delivery	Page 2
Assembly	Page 2
Putting into Operation	Page 2
Engine	Page 3
Engine Maintenance	Page 5
Pump	Page 6
Troubleshooting	Page 7
Warranty	Page 7
Technical Specifications	Page 8
Declaration of Conformity with EU Standards	Page 9



ATTENTION

Read these original instruction manual and the enclosed safety instructions before using your new device for the first time. Observe the instructions. Keep the instructions for possible later reference or for the next owner of the device.

Use of the Product in Accordance with Its Intended Use

This petrol engine powered pump can be used:

- only in private households;
- for pumping water mixed with chemicals from the tanks;
- with accessories and spare parts approved by WPW Center s.r.o.
- In an environment where the device will not be exposed to direct splashing of contaminated water with solid particles.
- It must not be used for pumping chemical solvents, flammable or explosive substances.

Environmental Protection



The packaging materials are recyclable. Dispose of packaging in accordance with the environmental policy.

Old machines contain valuable recyclable substances that should be reused. Old devices must be disposed of in an environmentally friendly way.

Cleaning work that produce waste water that contains oil, e.g. when cleaning the floor of the machine, can only be performed in a washroom with oil separators. Work with detergents may only be carried out on work areas sealed against leakage of liquid and connected to the sewage system for contaminated water. Avoid leakage of detergents and petroleum substances into water or soil.

Safety

Safety Instructions

Read the enclosed 'Safety Instructions' before using this device for the first time.



In order to protect hearing and sight, it's advisable to use protective equipment to muffle the noise and to protect your eyes from splashing water during the pump's operation.

Safety Symbols Used

When reading these operating instructions, you will encounter the following symbols.



- Read the operating instructions, observe warnings and safety instructions.
- Be especially careful and pay special attention.



- Use personal protective equipment.



- Hot surface! Don't touch the engine when it's hot!



Warning! Poisonous gases! Never use the engine indoors!



Warning! Danger of explosion or fire. Allow the engine to cool before refuelling!

Danger Levels



DANGER - A warning of imminent danger which may cause serious injury or even death.



WARNING - A warning of a potentially hazardous situation that could cause minor injuries.



CAUTION - A warning of a potentially hazardous situation that could cause material damage.

Safety Features



WARNING - Safety features serve to protect the user from injury and may not be altered or removed. In the event of damage, they must only be replaced with an original part.

Protective Covers for Hot or Rotating Parts



Protective covers are used to protect the pump operator from injuries due to the high temperatures of some parts of the combustion engine or from accidents caused by device's rotating part.

Scope of Delivery

The scope of delivery is shown on the packaging or on the order of the goods. When unpacking, check the completeness of the contents. Please inform the seller if any parts are missing or if you find any damage caused by transport.

Additional Requirements

A fabric-reinforced water hose with a diameter of at least 2" (50mm) for connection to the outlet terminal of the pump. A suitable hose with a reinforcement with a diameter of at least 2" (50mm) is required at the inlet. The maximum length of the outlet hose is 150 metres. Basic rule: The longer and thinner the hose, the smaller the water flow at the end of the hose. Engine oil.

Assembly

The device is assembled in the manufacturing plant.

Putting into Operation

WARNING Don't start the pump without pre-filling the pump with water. **Running a dry pump will damage the sealing element on the shaft.** When starting the pump, proceed as follows. Connect the suction hose with the suction strainer to Flange 1 on the front of the pump. It's essential that the joint between the hose and the pump is tight and there is no air intake

around the bearing surfaces. Then connect the outlet hose for pressure water to Flange 2. In the next step, it's necessary to pour water into the pump. Remove Cap 3 turning it to the left (anti-clockwise). Pour clean water into the pump up to the level of the mouth of the cap hole. The water won't flow out as the backflow valve prevents water from flowing through the suction pipe. Subsequently, put Cap 3 back into the pump turning it to the right (clockwise) and tighten it by hand. Check the tightness of Drain Cap 4. Excessive tightening with pliers may result in damaging the cap. Immerse the suction hose suction strainer into the water source needing to be pumped. After pumping is completed, any water remaining inside the pump must be drained by unscrewing Cap 4. Storing the pump filled with water over a long period of time will cause internal corrosion on the pump blades and scale on rotating parts, therefore, reducing the pump's life.

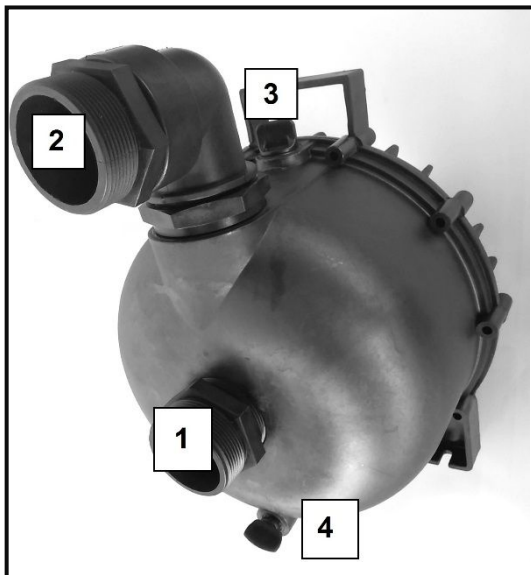

The outlet flange of the pressurized water can be rotated as required.



Start the engine and adjust the engine speed with the throttle. Refer to the ENGINE section for more information on starting the engine. It's necessary for the engine to run at higher revolutions until the pump takes in water from the source. The suction process can be seen through a transparent suction hose. If the pump doesn't exert pressure within 30 seconds after starting the engine, turn-off the engine and follow the Troubleshooting instructions. CAUTION: Draining water from a depth of more than 3 metres may require water replenishment to the pump as described in the Putting in Operation section.

Dry running for more than 60 seconds will cause pump damage! WARNING: If the pump takes in air, it's necessary to remove the leakage on the suction pipe and repeat the whole process of pouring water into the pump. Damage caused to equipment due to non-compliance with this instruction the warranty will be deemed invalid.

Engine



Oil plug with gauge

The engine **MUST** be filled with the correct amount of engine oil before its first commissioning. For specifics refer to the Technical data section. Set the pump on a horizontal surface. Open the oil sump plug, also fitted with the oil gauge. Fill the engine with approximately $\frac{3}{4}$ of the oil amount required. Screw the plug back into the oil sump. With the **C** switch set to the **OFF** position (see the figure below), cycle the engine by pulling the starter cord. Remove the plug, wipe the gauge dry and check the engine oil level.

CAUTION: To get the correct reading, the gauge must be fully screwed in place. Top up the oil to achieve the final level between the MIN and MAX marks.

Remove the plug and fill the tank with petrol carefully. To ensure full performance of the engine, use fresh petrol with the octane rating of 91 or higher. The physical properties of old and vapid petrol are different and it may cause an uneven run of the engine or reduced pump performance.

Use clean and oil-free petrol only - your engine is a four-stroke type.



DANGER
When in operation, the engine produces carbon monoxide, which is a colourless and odourless poisonous gas. Inhalation of carbon monoxide may cause nausea, headaches, dizziness, vomiting or even death! The device may be used outdoors only, with proper ventilation ensured. It is also necessary to prevent ingress of exhaust gases into enclosed rooms via unsealed openings. When working with the engine on, turn the device in such direction, where the exhaust does not remain pointed at persons standing in the vicinity or any opening in nearby structures (garages, galleries, cellars, etc.). When in operation, the engine produces waste heat, resulting in heat-up of various engine components (exhaust, engine cylinder), which may cause serious burns. These components may cause fire, when in contact with flammable materials.



Petrol fumes are extremely flammable and explosive substances that may cause burns, fire or even explosion, when handled improperly. Let the engine cool down for 5 minutes before adding petrol into the tank. Then proceed with careful removal of the tank lid and start pouring the petrol in with caution. NEVER fill the fuel up to the rim, since petrol warms up during engine operation and swells, which may result in leakage through the lid and subsequent explosion of fire. NEVER tip the high-pressure device into such position, where petrol may leak from the tank. NEVER attempt to start the engine with damaged components in the fuel supply, ignition or safety features.

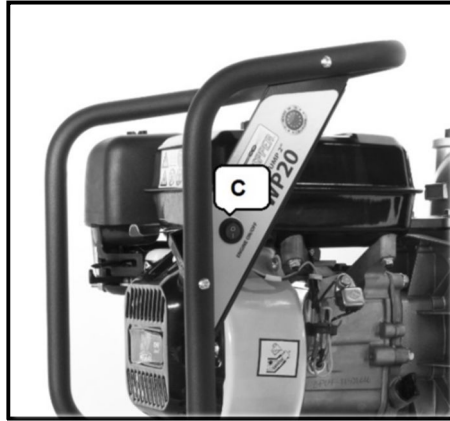

Push the engine switch **C** and the fuel switch **D** into the **ON (I)** position.

Shift the speed control lever **B**



into the **MAX** position.

Shift the choke control lever **A** into the **CHOKE** position.

Grasp the pump grip with one hand firmly and use the other hand to hold the starter cord grip. Pull the starter cord to the point,

where you feel resistance from the engine. Then pull the grip sharply to prevent recoil. If the engine fails to start on the first attempt, repeat the starting process by pull the starter grip again.

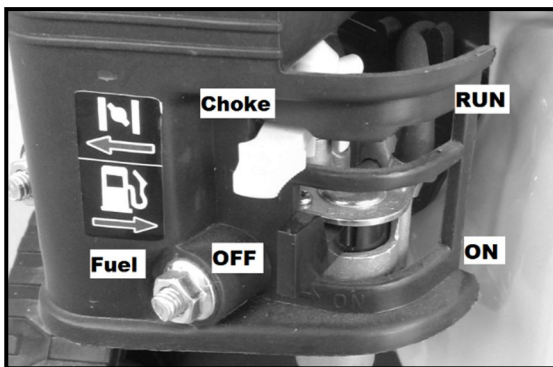

CAUTION! The starter cord recoil (engine resistance against the direction of starter cord pull) will draw your shoulder and hand towards the engine faster than you are able to release is, this may result in spraining, contusion or breakage of your limb.

Once the engine has started up, shift the choke control lever **A** into the **RUN** position **SLOWLY**.

ENGINE SHUTDOWN

Engine shutdown comprises the following steps

Shift the engine speed control lever (page 4) **B** to ½ of the turn towards the position  and let the engine run for at reduced speed for 15-20 seconds. Then proceed with turning the engine ignition switch **C** and the fuel switch **D** into the **OFF** position.

CAUTION The engine is fitted with the engine oil level sensor (not every model though) to switch the engine off, when the engine oil drops to hazardous point. **This function does not substitute the regular inspection of engine oil level.** Disregard to the regular inspections may result in irreversible damage to internal components of the engine. Such damage is not covered by the warranty.

NEVER spray any water on the engine when hot. Such actions may cause ingress of water into the fuel system or the ignition system. Clean the engine with a damp cloth and compressed air to remove dust from the air filter compartment.

Every 8 hours or daily	Check engine oil level Check the area around the air filter and exhaust for dirt
After the first 5 hours	Replace the engine oil
Every 50 hours or at the end of the season	Clean the air filter Replace the engine oil
Every 100 hours	Check and set the spark plug electrode Checking the fuel line

During operation, in rare cases, protective metal covers may become loose due to vibration. It's necessary to tighten these components as the long-term effect of vibrations on the loosened cover causes damage to the mounting holes. If the exhaust, air filter or cooling fan protective cover is damaged, these parts have to be replaced by original parts as this is the only case where maximum safety can be guaranteed.

Spare parts are available through the manufacturer or a certified service centre. A complete list of components is provided in this instruction manual or on the manufacturer's website.

Winter Storage

Proper long-term storage is crucial to achieving seamless operation in the following season. Extend the life of the engine by storing it properly.

The following steps will provide you with the maximum protection of engine components against corrosion and wear of sliding parts of the engine. The engine must be kept in a room and engine temperature must be less than 50 °C. Use a damp cloth to clean the engine from dust and dirt. After drying, treat any damage with paint or cloth saturated with oil. This prevents the air from entering the sheet metal and subsequent corrosion.

Open the fuel tank cap and check the amount of fuel in the tank. The long-term presence of fuel in the tank during storage has a bad influence on fuel quality. This can result in irregular engine running and reduced power. Remove petrol from the tank and carburettor through the drain screw located on the bottom of the carburettor. **DO NOT OVERTURN THE ENGINE.**

THERE IS A RISK OF OIL LEAKAGE! It's recommended to replace the engine oil at the end of the season. This extends the life of the engine.

Engine Oil Replacement

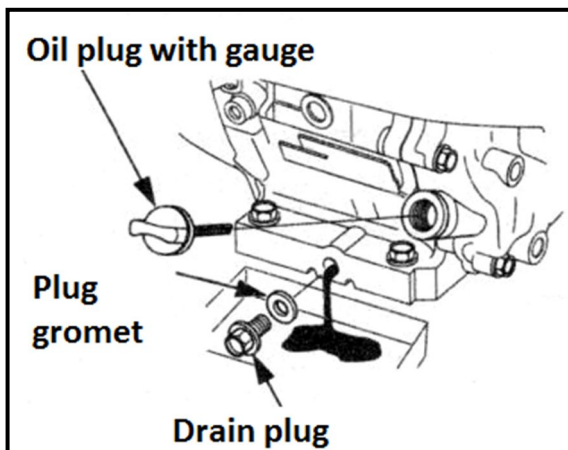

It is recommended to change the engine oil after use of this equipment (according to the Maintenance Schedule). Switch the engine off. Let the device cool down for a while, so its temperature drops below 50°C. This will prevent potential burns. The engine should remain warm still. **Warm oil drains from the engine more easily.**

- Unscrew the OIL PLUG WITH GAUGE.
- Place a container with the minimum capacity of 1 litre below the drain plug.
- Loosen the drain plug carefully.
- Let the oil drain smoothly into the prepared container.
- Once the oil stopped draining, tip the engine to the side

slightly to let the remaining oil out too.

- Clean the surroundings of the drain plug and re-tighten the drain plug in its place again.

-  Used engine oil must be delivered to one of the specified collection points. **Engine oil is hazardous waste!**

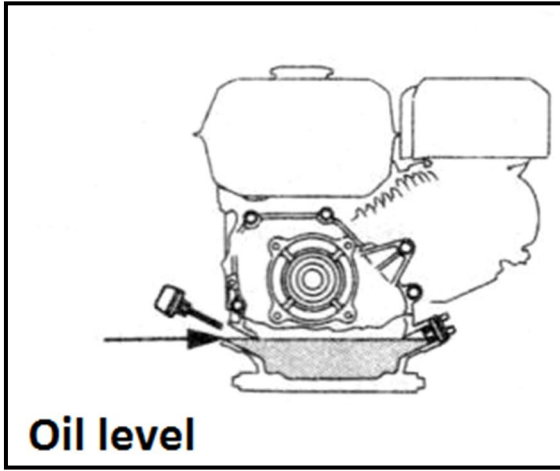

Fill the engine with the correct amount and type of engine oil. For engine oil specifications, see below.

- For specific filling volumes refer to the Technical data section.

- Set the pump on a horizontal surface.

Fill the engine with approximately $\frac{3}{4}$ of the oil amount required. Screw the plug back into the oil sump. With the engine operation switch in the **OFF** position, cycle the engine by pulling the starter cord. Remove the plug, wipe the gauge dry and check the engine oil level.

CAUTION: To get the correct reading, the gauge must be fully screwed in place. Top up the oil to achieve the final level between the MIN and MAX marks.

Engine Oil Specification

Engine oil is one of the main factors affecting engine performance and life.

The minimum requirements to be met by the oil are: viscosity class of 10W30 or 10W40 with quality level of SF and higher (SG, SH, SJ).

The use of 10W30 engine oil at temperatures higher than 27 °C can lead to increased oil consumption. Therefore, it's necessary to pay extra attention to the oil level if the device is operated at these temperatures with 10W30 oil. It's recommended to use 10W40 oil with the quality level of SF and higher (SG, SH, SJ).

The engine oil supplied exceeds the minimum quality requirements and ensures safe engine operation with minimal wear on inner parts under demanding operating conditions.

If it's necessary to add engine oil, use only the same oil type and brand as the one already in the engine. Mixing different types of oils isn't recommended!

Pump

Your pump is an all-plastic structure to guarantee long service life and trouble-free operation. The pump contains moving parts with a very precise fit. Therefore, it's **NECESSARY** that water supplied to the pump is free from major mechanical impurities. The dirt meshes the bearing surfaces in the pump and increases the play between the inner parts and reduce the outlet pressure.



DANGER



The pump produces high pressure at the outlet and as a result splashing water may have devastating effects on soft objects. It's **FORBIDDEN** to direct a stream of water towards humans or animals. Failure to obey this warning may have devastating effects, resulting in permanent blindness.



CAUTION

High pressure can cause damage to soft and sensitive objects. It isn't recommended to use a high-pressure water stream from the immediate vicinity for cleaning glass, non-coherent paint and plaster. Strong water flow can change the surface structure which may be permanent. In case of doubt, it's advisable to test the pressure water action on a sample where potential damage to its surface won't affect the functionality or appearance of an object.

Mechanical damage to inner parts of the pump due to contaminated water isn't covered by the warranty! Rubber and plastic sealing elements are used in the pump. For this reason **only water with a maximum temperature of 40 °C can be used in the water supply.**

Ensure that the water level in the container from which the water is taken is as high as possible to supply water into the pump. Small difference in the levels will make it easier to draw the water, therefore, reducing the risk of cavitation – a phenomenon that occurs when air bubbles begin to bubble out of the fluid. This can happen in the inside the pump if the vacuum at the inlet is too high – harder suction.

Therefore, use a hose with the largest diameter and as short as possible for suction purposes. Follow the instructions on page 2 (Putting into Operation).

Winter Pump Storage

Storing the pump in rooms where the ambient temperature is below freezing point can cause irretrievable damage to the inner components if the pump isn't drained properly!

Procedure to drain residual water from the pump: Switch off the engine. After pumping is completed, pump water must be drained by unscrewing Cap 4 (see pages 2-3 Putting into Operation). Storing the pump filled with water for a long time will cause internal corrosion of the pump blades and scale on rotating parts, therefore, reducing the pump's life.

Disconnect the supply hoses from the pump. Hold the starting cord handle and pull the cord **5 times** as if you are starting the engine. By doing so, the water from the inner parts of the pump flows through Cap 4. After draining the water, screw the cap back into the pump body.

It isn't recommended to store the pump in rooms where the temperature drops below freezing point as a significant change in outside temperatures can cause water vapour condensation even in areas where water is otherwise not available. This can cause internal corrosion and significantly shorten the life of the pump and the engine.

Troubleshooting

Problem	Cause	Solution
The pump cannot create the necessary water pressure, interrupted water flow, low water flow	<ol style="list-style-type: none"> 1. Water supply is blocked 2. Low water volume 3. Non-sealing joints on the suction side of the pump 4. Damaged pump 5. Incorrectly watered pump during self-suction 	<ol style="list-style-type: none"> 1. Check the free flow of water 2. Use a larger diameter hose or reduce the difference in the distance between the level and the pump 3. Check joint tightening, replace gaskets 4. Contact a service centre 5. Check the tightness of all connections on the suction side, water the pump as instructed on (pages 2-3)
The engine runs well without the load, but it's uneven when loaded.	<ol style="list-style-type: none"> 1. Low engine speed 2. Blocked pump 	<ol style="list-style-type: none"> 1. Adjust the position of the speed lever 2. Remove the cause of the blocked pump rotor
Engine stopped during operation	<ol style="list-style-type: none"> 1. The engine consumed fuel 2. The spark plug terminal dropped off 3. Low engine oil level 	<ol style="list-style-type: none"> 1. Add fuel into the tank 2. Check the spark plug terminal 3. Check the engine oil level and the possibility to spin the engine using the starting cord – add oil
The engine cannot be started or it can but runs unevenly	<ol style="list-style-type: none"> 1. Clogged air filter 2. There is no fuel in the engine 3. Old fuel 4. Spark plug terminal isn't connected to the spark plug 5. Inoperative spark plug 6. Fuel contaminated with water 7. Incorrect fuel/air mixture ratio 	<ol style="list-style-type: none"> 1. Clean the air filter 2. Add fuel into the tank 3. Replace fuel with new fuel or add more fuel 4. Check the spark plug terminal fitting 5. Replace the spark plug with a new one 6. Drain fuel from the tank and carburettor, and refuel with fresh petrol 7. Contact a service centre
The engine has no power	<ol style="list-style-type: none"> 1. Clogged air filter 2. Old fuel 	<ol style="list-style-type: none"> 1. Clean the air filter 2. Add fresh fuel into the tank

Only use original spare parts. This will ensure that your device is running smoothly.

Warranty

The warranty terms of our distribution organisation apply in every country. Any device defects will be removed free of charge during the warranty period if they are caused by a material failure or manufacturing failure. When applying the warranty, please contact your dealer or the nearest authorised service centre and have your purchase receipt. A list of approved service centres is available on our website: www.waspper.com

The effort of WPW Center s.r.o. is to continuously improve the technical characteristics and user comfort of its products. For this reason, the manufacturer reserves the right to change the design and controls of the device without prior notice to the final customer. The position of all the controls and safety features shown in this manual corresponds to reality. Changing the design of the control levers may not be recorded in these instructions.

Technical Specifications

Type of Device	WP20CH/P
Engine	Peggas 196cm3/ 3,8kw
Maximum speed	3600 rpm
Engine type	4 stroke OHV
Max. torque	10,7 Nm/ 2500 rpm
Spark plug	Brisk: LR14YC gap 0,7-0,8mm
	Champion: RN7YC
	NGK: BPR7ES
Petrol tank capacity	3,6L
Oil fill capacity	0,6L / 10w40
Maximum water flow and displacement	3bar/60m3/hod.
Net weight	22,5kg
Height	43,5cm
Width	42,5cm
Length	53,5cm
Self-suction function	Yes - 7m

Component Breakdown



Frame
Fuel tank
Muffler
Outlet port
Inlet port
Pump Body
Engine



EU Declaration of Conformity

The company WPW Center s.r.o. hereby declares that the water pumps defined below comply with the relevant EU directives on occupational health and safety of the device operators. Any alteration of the device without the prior consent from the manufacturer will render this declaration void.

Product details: Water pump

TYPE	Inspection reports	Noise level measured	Guaranteed noise level
WP20CH/P	3748/3/2018-13	95dB	97dB

Certificate issued by: TECHNICKÁ INŠPEKCIA a.s., pracovisko KOŠICE, as an accredited inspection body in accordance with EN ISO / IEC 17020

Applicable EU Directives:
2006/42/ES

Standards applied:

EN ISO 12100:2010

EN ISO 9906:2012

EN 809:1998+A1:2009+AC:2010

Producer:

WPW Center s.r.o, Radlinského 20, 05201 Spišská Nová Ves, Slovensko

Issued in: Spišská Nová Ves

Manufacturer's representative: Dobroslava Šupolová

Issue date: 15.10.2018

Position: Managing Director

Warranty Certificate

Product type:	WASPPER	Stamp and signature:
Serial number:	Date of purchase:	

In pursuit of service enhancement and simplification of communication with customers, the company WPW Center s.r.o. recommends its customers, who purchase this product, to register their product via the manufacturer's website: www.waspper.com. This registration will provide inevitable data for faster processing of your complaints or consulting relevant to purchasing of spare parts and accessories. This registration enables the customer to avoid further procedures, as submitting of the purchase receipt or the warranty certificate.

1. The manufacturer - WPW Center s.r.o. - is liable for inherent defects of the product purchased, if such defects become evident within the warranty period. Application of claims for repairs under warranty requires completion and submission of the complaint form via the manufacturer's website: www.waspper.com. The product is covered by a full warranty of 24 months for private customers (as defined by the Civil Code) and 12 months for corporate customers (as defined by the Commercial Code). The warranty period commences upon completion and submission of the complaint report via the website in case of simple defects and damages. The commencement of warranty in case of major defects starts upon the product delivery to the manufacturer's address: WPW Center s.r.o, Radlinského 20, 05201 Spišská Nová Ves. Acceptance of complaint will be notified to the customer using the contact details entered in the complaint form.

2. The warranty does not cover defects incurred due to: wrong operation; improper handling or use contradictory to the operation manual or instructions and recommendations from the company WPW Center s.r.o; use or storage of goods within inappropriate areas, especially with respect to temperature, dust formation or ambient humidity; exposure to direct sunlight; damage attributable to natural disasters of force majeure. The warranty does not apply to mechanical damages, any damages due of solid particles, frost or other weather effects. The warranty does not apply to damage to the pump caused by cavitation. Other exemptions from warranty include damages to the engine due to lack of oil and ingress of any other but operating fluid among internal engine components.

3. Particular steps of claims processing will be notified to the customer following assessment of the scope of repair by the claims engineer. Whenever the replacement of a damaged component can be performed by the customer, the latter will receive a relevant spare part only. If the repair by a servicing centre is inevitable, the customer is obliged to mail the damaged device to the manufacturer's address. The device must be complete (including accessories) and packed properly to prevent its damage during transport, it must be free of mechanical damage and contain no operating fluids. If the goods submitted to the servicing centre shows evident signs of damage or excessive wear, the manufacturer reserves the right to reject such consignment without acceptance.

4. Claims for repairs under warranty oblige the customer to provide the receipt of purchase (invoice, cash receipt) together with the warranty certificate and written description in support of their claim, including photographic documentation. It is recommended to complete the complaint form via the manufacturer's website to ensure the fastest processing of the claim as possible, if the manufacturer acknowledges such claim as justified, the repaired item will be sent to the customer and the postage/freight will be covered by the manufacturer.

5. If the claims engineer finds out the product does not comply qualifications for repair under warranty, the claim will be considered unjustified and the costs of product transport to the customer will be paid by the latter.

6. Should the repair period exceed 30 days or if the product is irreparable, the customer will be offered a replacement item.

7. Justification of claims will be assessed by the claims engineer at the manufacturer. Justified claims will extend the warranty period by the period taken by the claim processing period. Such action will be confirmed to the customer by means of a document in writing, dispatched together with the product or sent via e-mail. If the product subject to claim contains any discontinued component, the manufacturer will provide the customer with an adequate replacement item with its parameters corresponding with the returned product or even better.

8. The customer undertakes to read all the information found on the packaging or in the operation manual; to do so immediately following the product delivery, to acknowledge that preservation of the positive characteristics of the product delivered will be subject to its proper operation and storage. Any disregard to obligations defined herein relieve the company WPW Center s.r.o. from any liability for defects of goods or damages incurred due to breach of this obligation by the customer or any other third party. The customer is obliged to check the intact condition of packaging and product during the purchase and takeover of the consignment from the postman. Any damage to the packaging must be reported to the carrier and recorded immediately. Any damages found only after unpacking of the product must be notified to the distributor within the maximum period of 4 working days. No later claims for product damage can be accepted.