

# Operation manual

EN

GF1000  
GE1065HD



Motor-driven

**POWERED by**  
**HONDA™**

**Original Manual of Use**

\*The picture of the device is illustrative and it doesn't have to comply with the actual view of the device

## CONTENTS

Product use in compliance with its determination	pg. 1
Environment protection	pg. 1
Safety	pg. 1
Scope of the supply	pg. 2
Assembly	pg. 2
Entry into service	pg. 3
Engine	pg. 3
Engine maintenance	pg. 5
Pump	pg. 6
Help with failures	pg. 11
Guarantee	pg. 11
Technical data	pg. 12
Declaration of compliance with EU standards	pg. 12



## WARNING

Read this original manual of use and included safety instructions before the first usage of your new device. Act accordingly. Keep the manual for a later usage or for another owner of the device.

## Product use in compliance with its determination

This high-pressure washer can be used:

- With the sufficient amount (min. 50L) of the clean water in the tank.
- for washing of machines, vehicles, buildings, tools, facades, building exteriors, garden tools etc., along with the high-pressure stream of water (in case of need with adding detergents);
- with accessories and spare parts approved by the company Waspper s.r.o..
- In the environment without any direct exposure to the splashing polluted water with the solid particles.
- The device has to be stored in the environment protected against the weather conditions.

## Environment protection



Package materials can be recycled. Dispose the package according to the ecological rules.

Old machines contain evaluable recycling substances, which should be reused again. The old machines have to be disposed ecologically.

Cleaning operations, out of which waste water with oil content arise e.g. during engine cleaning or cleaning of the machinery floor, can be executed only in the washrooms with the oil separators. You can execute the work with detergents only on workplaces sealed to be impermeable to fluids outflow and attached to the sewer system for the polluted water. Avoid emission of detergents to the aquatic resources or soil.

## Safety

### Safety instructions

Before you use this device for the very first time, unconditionally read included "Safety instructions for the high-pressure washers".

Acoustic protection devices and eye protection devices are appropriate to use during operation of the washer



for the purpose of acoustic and eye protection.

## Levels of danger

 **DANGER** - Warning before imminent danger, which may cause serious injuries or death.

 **WARNING** - Warning before a possible dangerous situation, which could result in minor injuries.

 **WARNING** - Warning before a possible dangerous situation, which could result in material injuries.

## Safety elements

 **WARNING** - Safety elements serve for the user protection against injuries and they mustn't be altered or withdrawn from their operation. In case of damage they have to be replaced only by an original spare part.

### Security covers of hot or rotating parts



Security covers serve for protection of the high-pressure washer against injuries resulting from the high temperatures of some parts of combustion engine or against the injury caused by the rotating parts of the device.

### Security features of the combustion engine and pump

Safety switch of the low level of engine oil serves for an automatic engine shutdown in case the oil level decreases below the minimal level. We avoid the engine damage caused by insufficient lubrication of internal parts in this way. However, this safety element does not substitute the obligation to check oil level before usage of the device.

Further important information is in the part – ENGINE (pg. 3).

Water level sensor in the tank serves for the secure switching off the pump in case there is not sufficient amount of the water serving for engine cooling.

Temperature indicator placed on to the pump serves for engine protection against the water with the temperature higher than the maximum operating temperature of the engine.

Vacuum sensor placed near the water filter serves for engine protection when filter element of the water filter is choked. It would cause a higher risk of cavitation and premature wear of the pump. Important information is in the part - PUMP (pg. 6).

## Scope of the supply

Content of the delivery device is portrayed on the package or in the order of goods. After unpacking check the completeness of the content. If some parts are missing or you find damages arisen during the transport, please, inform the seller about it.

### It is required additionally

Clean water resource for the filling the tank or direct supply of the pump by pressurised-water with the yield of 15L/min.

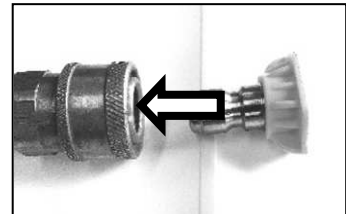
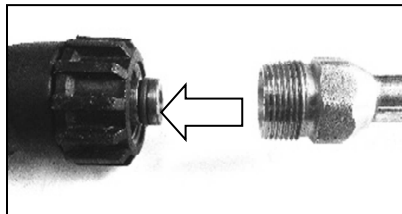

## Assembly

The single device is assembled in the production plant. Complete the pressure gun, extension piece and nozzle. Attach the high-pressure gun at the ending of the high-pressure hose. In the next step it is necessary to fill up the engine with delivered engine oil according to the instructions in the section **ENGINE (pg. 3)** and pour fresh petrol with octane number 95.

## Entry into service

### Supply with water

**WARNING** Do not start up the pump without water in the tank. The minimal amount is around 50L. The pump switches off in case of lower water level. The water in the tank has to be clean, without solid particles or mud. Polluted water damages internal components of the high-pressure pump and clogs the water filter prematurely and sucking of water from the tank becomes more difficult. It can result into the automatic engine shutdown. Unless the pump exerts the pressure until 30 seconds after engine start-up, switch off the engine and proceed according to the instructions in the section **Problems solution!** Dry run for more than 30 seconds causes pump damage!

Damages on the equipment for the reason of failing to obey this instruction result in the termination of the guarantee.

### Engine



Oil plug with gauge

It is **NECESSARY** to pour the right amount of the supplied engine oil to the engine before the first start-up of the pump. Packed engine oil bottle **can contain bigger amount of the filler** than it is necessary for the given type of the engine. The exact amount of the filler is laid down in the Technical specification. We advise to decrease the outlet pressure of the water according to the instructions on the **page 8** for smoother start-up of the cold engine.

Place the pump on the horizontal surface. Open the plug of the oil sump where the oil dipstick is located. Pour around  $\frac{3}{4}$  of the required amount of the oil to the engine. Screw the plug in the engine. At the position of the switch **C** in the position **OFF (0)** (picture at the bottom) rotate the engine by pulling the start-up lead. Open the plug, wipe the dipstick and check the engine oil level.

**CAUTION:** The dipstick shows the correct oil level only after the full screwing up to the engine cut out. Pour in the oil in the way, so the oil is in the top half between MIN and MAX.

Open the plug of the tank and pour the petrol into the tank. The fresh petrol with octane number 91 and more is necessary to use for the full engine power. The old petrol has different physical characteristics and can cause the engine hunt or the decreased pumping capacity. **Use only the clean petrol without oil additions - Your engine is of four-stroke type.**



### DANGER

Running engine produces the carbon monoxide, colourless and poisonous gas without odour.

Inhalation of carbon monoxide may cause nausea, headache, dizziness, vomiting and death!

The device can be used only in the outer environment where the proper ventilation is ensured. It is also necessary to ensure that the exhausted gases wouldn't get to the closed rooms through unsealed hatchways.

If you work with the running engine, turn the device in the direction so that the standing people and hatchways of the buildings (garages, porches, cellars etc.) do not face the exhaust pipes.

The engine produces the waste heat during operation which results in the presence of many hot components (exhaust, engine cylinder), which can cause the serious burns in case of touching. There is a fire hazard if these hot components come into contact with flammable materials.



### DANGER

Petrol vapours are extremely flammable and explosive and in case of the wrong manipulation they can cause burns, fire or explosion.

Let the engine cool down for 5 minutes before pouring the petrol into the tank. Then open the tank hood and start to pour the petrol to the tank carefully. **NEVER** fill up the petrol to the edge because it heats and spreads during engine usage and that can cause the petrol leakage through the plug followed by the explosion or fire. **NEVER** turn over the high-pressure device to the position where the petrol could leak from the tank.

**NEVER** try to start up the engine if the components of fuel supply, ignition components or security features are damaged.



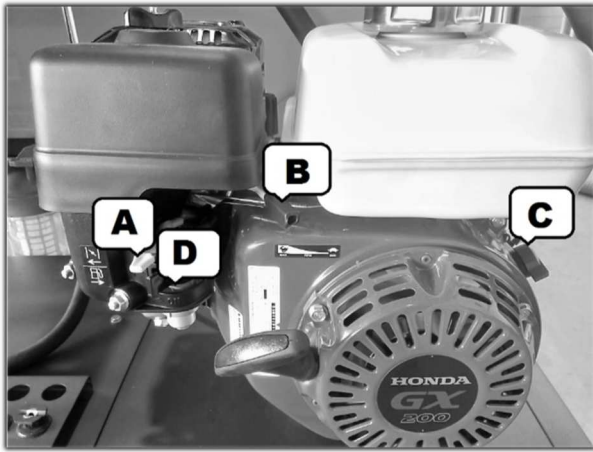

Turn the engine switch **C** and fuel **D** to the position **ON (I)**.

Move the gear control lever **B** to the position  .

Move the choke control lever **A** to the position **CHOKE**. Hold the pump handle firmly by one hand and jump start leads handle by another hand.

Pull jump start leads until you feel the engine resistance. Then pull the handle sharply to avoid the back run.

If the engine does not start up for the very first time, press the gun and release the accumulated pressure of the water in a safe way. Then repeat starting by pulling the jump start leads.

Start-up can be made considerably easier by pressure decrease.

**WARNING** Back ran of the jump start leads (engine action against the movement of the jump start leads) pull your shoulder and arm towards the engine faster than you are able to leave hold of it. It can cause wrenches, contusions or fractures.

After starting move the choke control lever **A** SLOWLY to the position **RUN**.

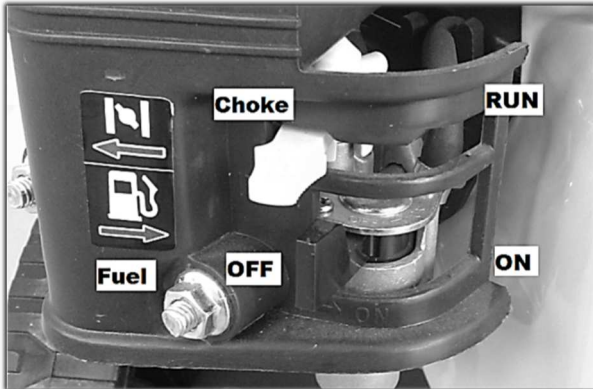

**ENGINE SWITCH OFF**

Engine switching off proceeds according to the following steps

Move the engine speed control lever (page 4) **B** to the half, towards the position  and let the engine run on cut down revolutions for 15 - 20 seconds. After that turn the engine switch **C** and fuel **D** to the position **OFF (0)**.

**WARNING:** The engine is equipped with the engine oil level sensor which switches off the engine if the oil level cuts down to the dangerous level. **This function does not substitute the regular engine oil level check.** Failure of the control can result in unrecoverable damage on the internal engine components. Such a damage is not covered by this guarantee. The device is also protected by vacuum sensor in the suction pipes, water level sensor in the tank and water temperature sensor in the pump.

**NEVER** spray water on the hot engine. Such as action can cause ingress of water into the fuel or ignition system. Use a wet cleaning rag to clean the engine and compressed air to exhaust the dust from the filter area.

**MAINTENANCE**

Every 8 hours or daily	Engine oil level check Air filter area check and check of the impurities from the exhaust.
After first 5 hours	Change of engine oil
Every 50 hours or at the end of the season	Clean the air filter Change of engine oil
Every 100 hours	Checking and setting up the electrode of the sparking plug. Checking fuel lines

During operation, in certain cases, the protective covers made of tin can be released because of vibrations. These components need to be tightened because an action of long-term vibrations on the released cover causes the damage of fixing holes. In case the protective cover of the exhaust, air filter or cooling fan is damaged, these parts have to be replaced by the original spare parts because only in this case the maximum operation safety can be ensured.

Spare parts are available through the producer or certified service point. Complete list of the components is published in this manual or on the Internet sites of the producer.

## Winter storage

**Correct long-term storage is a key to attain trouble free operation in the next season. You prolong the service life of the engine by the correct storage.**

Following steps provide the maximal engine components protection against corrosion and wear of the engine slide parts.

The engine cannot run and engine temperature has to be lower than 50°C. Clean the engine from dust and impurities with a wet cleaning rag. Clean potential damages with paint or an oily rag after drying. In this way you prevent the tin from interaction with the air, followed by corrosion.

Open the fuel tank plug and check the amount of the fuel in the tank. Long-term presence of the fuel in the tank during storage has a negative impact on the fuel quality. It can result in engine hunt or decreased engine power. Discharge the petrol from the tank and carburettor by a means of the relief valve screw placed at the bottom part of the carburettor. **DO NOT TURN ENGINE OVER.**

**THERE IS A DANGER OF OIL LEAKS! We advise to change the engine oil at the end of the season. The service life of the engine will be prolonged.**

## Change of engine oil

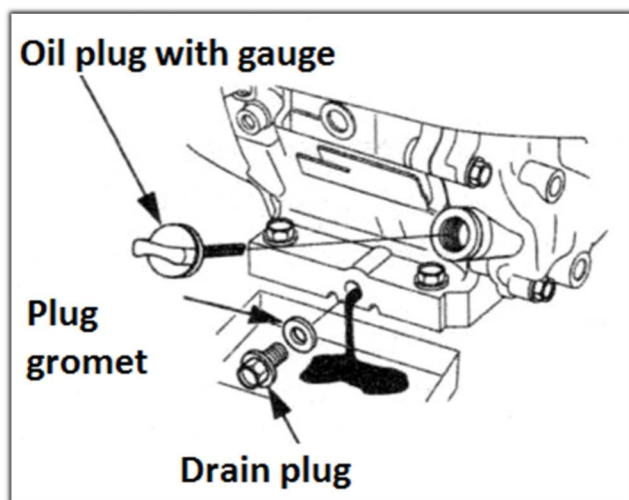

We advise to change the engine oil after use of the device (according to the maintenance plan). Switch off the engine. Let the device cool a little bit, so the temperature is lower than 50°C. You will avoid potential burn injuries. It is appropriate for the engine to remain warm. **The warm oil leaks out from the engine more easily.**

- Unscrew the OIL PLUG WITH THE DIPSTICK.
- Place the pot of the minimal volume of 1L under the relief valve screw.
- Release the relief valve screw carefully.
- Let the oil flow out freely to the prepared pot.
- If the oil already stopped leaking, decline the engine mildly so that the rest of the oil would leak.

-Clean the area of the relief valve screw and tighten it back to its original place.

 Used engine oil is necessary to hand in some of the collection centres for this purpose. **The engine oil is dangerous waste!**



**Hour meter.** The device contains hour meter. The total engine hours (time cannot be deleted), partial engine hours (time can be deleted by button) are recorded. Immediate engine speed, Tasks reminders. Hold the button minimally for 2 seconds to delete the reminder on the recording of the total engine hours. Hold the button minimally for 2 seconds to delete the reminder on the recording of the partial engine hours.

Pushbutton switching enables to switch from engine hours to revolutions and from the data engine hours to RPM data.

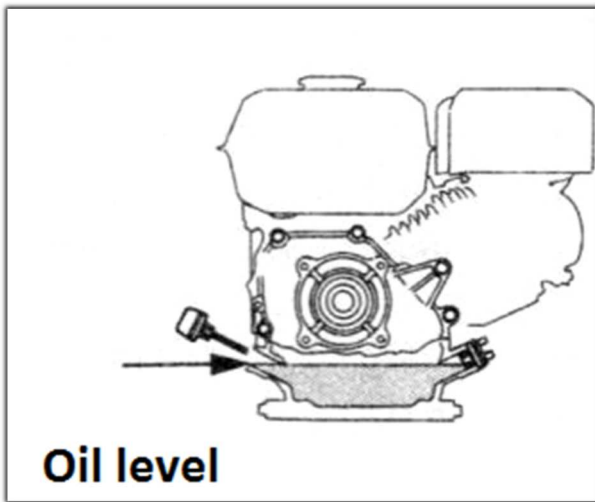

Pour the right amount and type of the engine oil into the engine. The oil specification is laid down below. - The accurate amount of the filler is written in the Technical specification.

- Place the pump on the horizontal surface. Pour around  $\frac{3}{4}$  of the required amount of the oil to the engine. Screw the plug in the engine. At the position of the switch **C** in the position **OFF (0)** (picture at the bottom) rotate the engine by pulling the start-up lead. Open the plug, wipe the dipstick and check the engine oil level.

**CAUTION:** The dipstick shows the correct oil level only after the full screwing up to the engine cut out. Pour in the oil in a way that the oil is in the upper part, between marks MIN and MAX.

### Engine oil specification

The engine oil is one of the key factors influencing power and service life of the engine.

Minimal requirements for oil are: Viscosity class 5w30, 10W30 or 10W40 with the quality class at least SF and more (SG, SH, SJ). The usage of the engine oil 10W30 in temperatures higher than 27°C can result in the higher oil consumption. That is why it is important to pay higher attention to the oil level if the device operates under these temperatures and oil 10W30. In such as cases we recommend to use the oil 10W40 of the quality class SF and higher (SG, SH,SJ). The delivered engine oil exceeds the minimal requirements for the quality highly and ensures the safe engine operation with the minimal wear of the internal parts under the tough operating conditions.

**If the engine oil is necessary to be refilled, use only the same type and brand-mark already present in the engine. Mixing of different oil types is not recommended!**

### Pump

Your pump is of all-metal character and so it ensures the long service life and non-fault run. There are moving parts with their accurate location in the pump. Because of that fact it is **NECESSARY** that the water coming into the pump would be without mechanical impurities. These impurities abrade the landing areas of the pump, by means of which clearance between the internal components increases and the outlet pressure decreases.



### DANGER

The pump generates too high pressure in the outlet and as the result the blowing water



has devastating effects on soft objects. Aiming water jet at people or animals **IS FORBIDDEN**. Failing to obey this warning can have devastating effects with the results such as permanent blindness, cut wounds, amputations and death.



### CAUTION!

The high pressure can cause damages on soft and sensitive objects. It is not recommended to use the water jet with the high pressure to clean rubber and tyres, glass, non-cohesive varnish, coating and timber. If too strong water flow is applied, the surface structure can alter or change permanently. In case of doubts we advise to try application of the pressurised-water on the sample where the potential surface disturbance will have no impact on the functionality or appearance of the object.

If you move the nozzle farther from the cleaning object, the pressure of the falling water decreases and the washing effect is less aggressive. On the contrary, movement closer to the object results in higher washing effect along with more aggressive washing effect on the object.

## Safety elements



There is a water filter in the water entry to the pump. This filter needs to be checked and cleaned regularly. Deposited impurities cause decreased flow and increased vacuum during suction of the pump. It causes deactivation of the engine safety system and the engine switches off. Change the damaged filter or its rivet for a new one immediately.

**The guarantee does not apply for the mechanical damage on the internal parts of the pump caused by polluted water.**

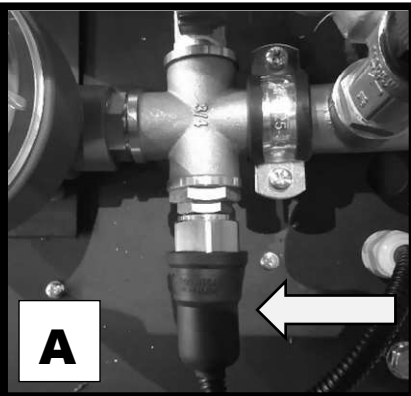

### Vacuum switch (pic. A)

His role is a control of the vacuum level in the sucking part of the pump. Too high vacuum, which is caused for example by choked water filter, causes cavitation and cuts down the service life of the engine. If the vacuum is too high, the sensor switches off the engine.

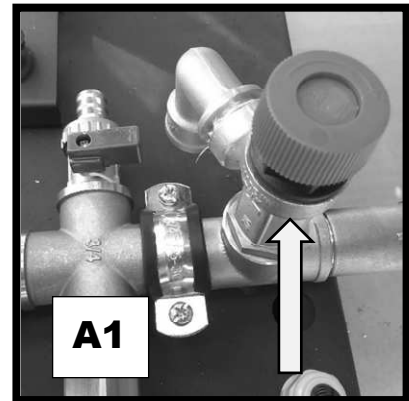

**Overpressure relief valve (pic. A1)** for the system protection against the pressure higher than **6 bar**.

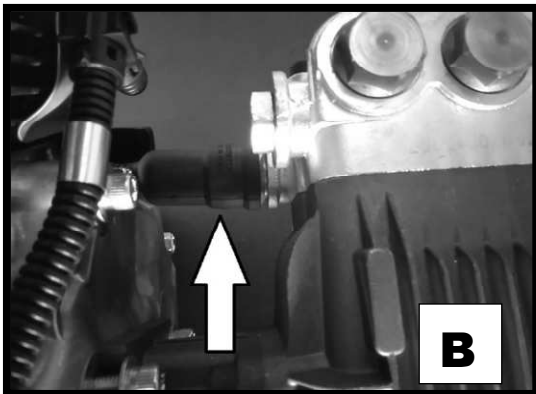

### Thermostwitch (Pic. B)

Its role is to protect the pump against the overheating. The process of the excessive heating occurs if the engine is still running but the high-pressure gun is switched off and no water is running from the nozzle. The pump switches automatically to outer water circulation. The water warms up by a continuous water cycle. The rule is applied that the less water in the tank, the sooner it warms up. **Because of this reason, only the water of the maximal temperature of 40°C can flow into the water supply since if the temperature reaches 50°C, this switch turns off the engine and keeps this state until the pump is cooled.**

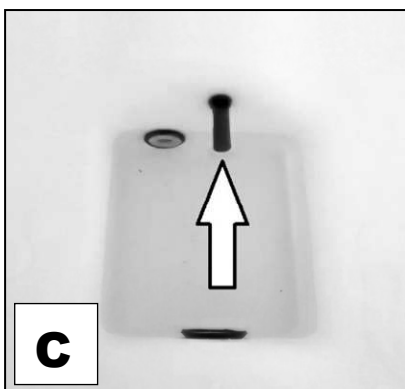

### Water level switch (pic. C)

The role of this switch is a control of water level in the tank. The minimal amount is around 50L. This amount of water is necessary for the engine cooling during the idling state. If the water level in the tank decreases below the minimal level, this switch stops the engine and keeps this state until the sufficient amount of the water is refilled into the tank. The same applies in case of pressure water usage for the supply of the pump.



## Pump preparation for the operation

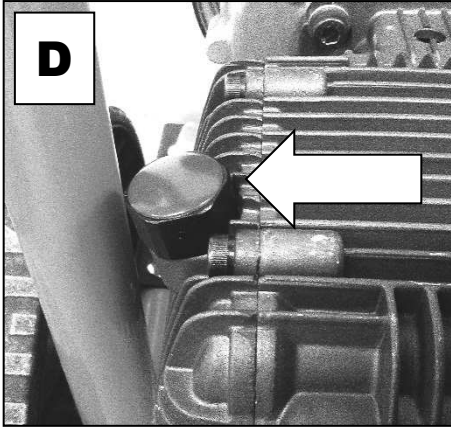

The pump is filled up with the industrial oil. Because of the oil temperature change and thermal expansion during the operation, there is an AIR VALVE (pic. D).

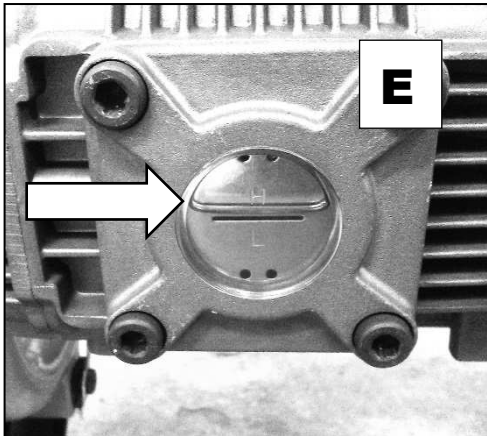

The operation of the pump with the low oil level or without oil causes the permanent damage on the pump and ceases the guarantee. Fill in the oil to the half of the control sight glass. Check the oil level before every use.

Place the pump to the horizontal position to check the oil level height. Otherwise the recorded level will not correspond with the reality. The oil level has to be in the required latitude during the operation, so that the proper lubrication of the internal components is ensured. You can check the oil level on the control sight glass of the pump (picture E). **It must be located close to the mark in the centre when the engine is switched off. If the oil in the pump is necessary to be refilled, use exclusively oil of the class: 15w40 SF-SJ. Do not exceed the maximal oil level! It can cause the damage on the shaft seals and oil leak from the**

pump.

**The pump run without water or dry can cause a permanent damage on the pump and ceases the guarantee. Check the inflow of water before every use!**

### Regulation of the water pressure in the outlet

This pump enables to regulate the water pressure in the outlet in the scope of 80 Bar- 220Bar. If you want to change the pressure, turn the controller located on the pump (picture F). Rule: when viewed from the top, the pressure increases if you turn **TO THE RIGHT** (direction of the watch rotation) and decreases if you turn **TO THE LEFT**. The engine load and fuel consumption grows with the increased pressure. Because of this fact the water pressure is appropriate to be modified on the base of the particular situation. If you cut down the pressure, you will prolong the service life of the engine and pump

### Maintenance of the pump

**Change the oil in the pump after first 50 hours of operation and then every 200 hours of operation. Use**

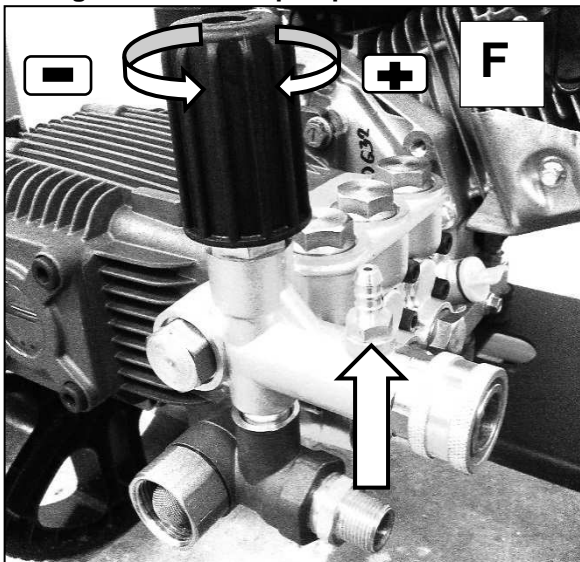

**the oil of the class 15w40 SF-SJ to change it. Release the plug located on the side part of the pump and drain the oil from the pump. Decline the pump, so the oil would leak from the pump housing. The oil is recommended to be changed after using, while it is warm, it leaks more easily and impurities are dispersed in the oil. After the old oil leaks out, screw back the relief valve screw, pour the oil through the opening of the plug and at the same time check the level on the control sight glass. **Proceed carefully because the oil flows slowly inside the pump and it can often overflow.** After the oil reaches the necessary level, screw the air plug back to the cover of the pump.**

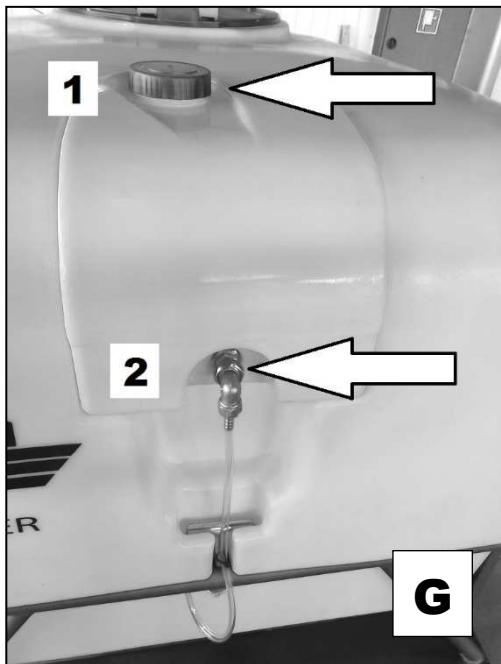

### Usage of self-priming function of detergent

The pump has self-priming function by use of vacuum from the pot. The black nozzle, determined for the purpose of detergent usage, is needed to start this function. The pump starts to suck the detergent itself through the opening marked by the arrow (pic. F). Pour the necessary amount of the detergent into the storage tank (1 pic. G). The maximal amount of the detergent is 15 litres. The detergent is applied diluted by water in the proportion 1:12 (1 portion of the detergent and 12 portions of water). This amount changes according to the outlet pressure and detergent's density. In case the detergent is not sucked, check the sieve located at the outlet from the storage tank ( in the internal part of the brass nut 2 pic. G). Apply the detergent by pressing the pushbutton on the gun. **This configuration does not serve for creation of active foam.** It is necessary to buy a foam lance if we want to create the active foam (category No SP000-FL002).

### Winter storage of the pump

**Storage of the pump on places where the environment temperature is under the freezing point can result in unrecoverable damage of the internal components if the pump is not drained properly!**

Process of discharging the remaining water from the pump: Make sure that the engine switch (pg. 4 pos. C) is in the position **OFF (0)**.

Unscrew the nut 2 (picture G) and discharge the water from the detergent tank. Start the engine. Put the black nozzle into the extension piece and press the pushbutton. In such a way the remaining amount of the detergent should get out from the detergent tube. The process of the detergent discharge is visible in the transparent tube of the pump in the form of bubbles. If the detergent flows only from time to time, the engine can be switched off. If there is any amount of liquid in the storage tank, disconnect the connector 2 (pic. G) in winter.

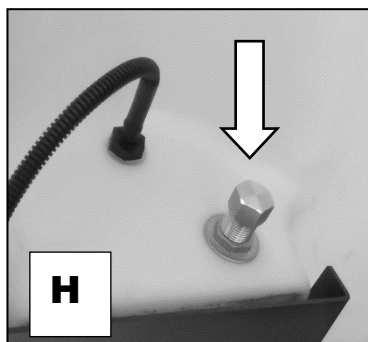

Then discharge water from the main tank. There is a connector with a plug placed at the bottom side (pic. H). Take away the plug and let the water flow out.

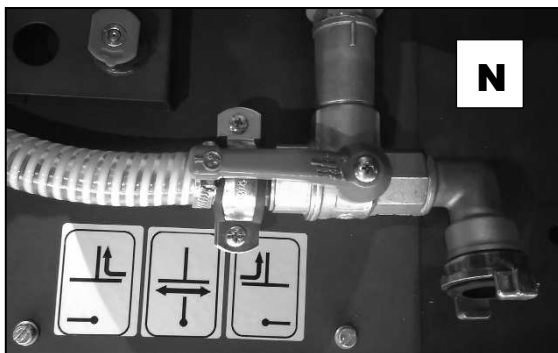
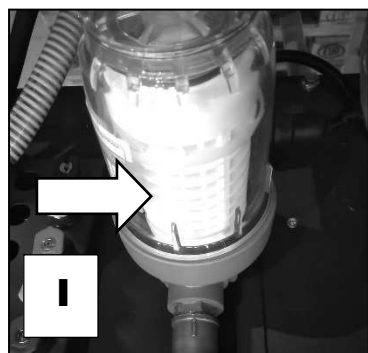

After flowing out all water, unscrew the transparent cover of the water filter at the bottom (pic. I) and pour out the water.

Switch the 3-way valve (pic. N) gradually to all positions and let to flow out the water from the pipes.

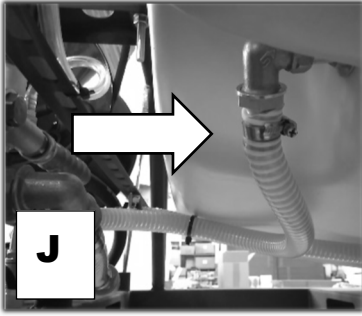

Take away the hose of the pipe directed downwards ( pic. J) and decline the hose to enable outflow of all water from the pump. Leave the hose disconnected until the outflow process of water is finished.

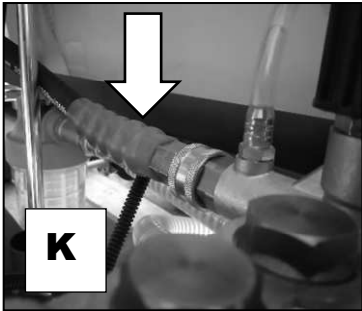

Disconnect the high-pressure hose in the outlet (pic. K). Then hold the jump start leads handle and pull the lead for **10 times** like when starting the engine. The water gets out from the pump through the high-pressure opening in this way. Pick up the back part of the frame, so that water could also flow out from the supply hose between the tank and water filter. It is not recommended to store the pump in the room where the temperature drops below the freezing point. Any substantial change of the external temperatures can cause water vapour condensation also in the space where water does not get under normal conditions. That can result in internal corrosion and significant reduction of the pump and engine service life.

## Preparation for operation

Place the tank frame on the straight surface so that after filling any vibrations wouldn't move it. Check if all hose edges are tightened enough and assembled on the right place. The detergent is not necessary to be filled into the storage tank if its usage is not required. It has no impact on the operation of the high-pressure washer. Turn the tank cap in the direction of the arrow, marked as OPEN on the cap ( pic. L), and open it. Fill in the tank with clean water of the required amount, maximally 1000L. You can observe filling it on the scale (pic. M). It is necessary to aim the water stream in the direction that would not result in the damage on the switch placed in the centre of the tube bottom. Then close the tank cap in the direction of the arrow. You will avoid contamination of the water by impurities and water outflow during transport. **Some amount of the water can flow over the cover if the movement is stronger and the tank is full. The cover is not water resistant!** If the required transport is over big rough terrain, it is appropriate to fill the tank up to  $\frac{3}{4}$  of its capacity.

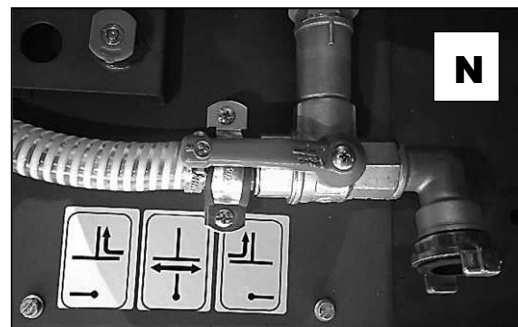
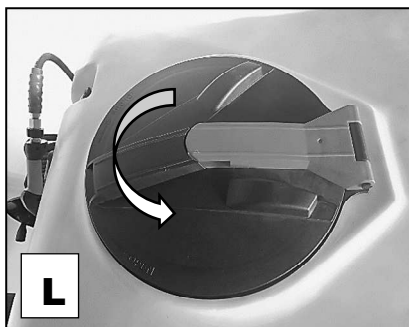

**Use of 3-way valve:** The tank can also be filled via connector, placed on the front side of the frame. The position of the 3-way valve is necessary to be set up right according to the instructions on the pictogram ( pic. N). The rule applies: The position of the valve handle marks **CLOSED** way. **1.** The valve handle has to be turned in the direction toward the water filter if we want to fill the tank or get away water without the pressure washer. **2.** If we want to use the pressure water without previous tank filling for the high-pressure washer supply, let's place the valve handle to the left. **CAUTION! The sufficient amount of water has to be in the tank to set up work position of the float (upwards). Otherwise engine protection blocks the engine. When the engine is in the idling state, the overflow water will flow into the tank.** **3.** If we want to use the water from the tank for the high-pressure washer supply, we switch the valve to the left after previous filling in water to the tank.

Cut down the outlet pressure of the water according to the instructions in the section: **Regulation of the water pressure in the outlet.** The force necessary for starting cuts down by this step. Place the nozzle with the required angle of the water jet to the ending of the metal extension piece of the high-pressure gun. Start the engine according to the instructions in the section **ENGINE.** **CAUTION!** The engine has to be filled with the engine oil and petrol before starting. Set up the required water pressure. If the pump was not used for a longer period, sucking water to the pump will take up to 20 seconds.

The engine switches off if: There is not enough oil in the engine - there is not enough water in tank - water sucking gets more difficult because of the choked water filter - the temperature of water or valve pump head more than 45°C.

## Problems solution

Problem	Cause	Solution
The pump is not able to create the necessary water pressure, low water flow	<ol style="list-style-type: none"> <li>1.The nozzle with a big hole is used</li> <li>2.The water supply is blocked.</li> <li>3. Low volume of the incoming water</li> <li>4.Choked the sieve for incoming water</li> <li>5. The high-pressure hose is choked or the water leaks</li> <li>6. Too high temperature of the input water</li> <li>7.The pressure releases from the gun</li> <li>8.Choked nozzle</li> <li>9.Damaged pump</li> </ol>	<ol style="list-style-type: none"> <li>1. Change for the right dimension of the nozzle</li> <li>2. Check the uncontrolled water flow</li> <li>3.Use the higher water pressure or the hose with the longer diameter</li> <li>4.Clean the sieve or replace by a new one</li> <li>5. Remove the impurities, turn the hose, rinse or replace by a new one</li> <li>6.Provide the colder water</li> <li>7. Check the joints tightening, change the gun</li> <li>8. Clean the nozzle with a steel wire and rinse it with a stream of water</li> <li>9. Contact the service point</li> </ol>
Pump does not take the detergent	<ol style="list-style-type: none"> <li>1. Wrong nozzle is used</li> <li>2.Insufficient amount of the detergent in the storage tank</li> <li>3. The tube or sieve is choked</li> </ol>	<ol style="list-style-type: none"> <li>1.Change the high-pressure nozzle for the low-pressure (black) one</li> <li>2.Check the amount of the detergent</li> <li>3. Clean the hose with the stream of water, change the suction tube</li> </ol>
The engine runs well without the load but it jerks if loaded	<ol style="list-style-type: none"> <li>1. Low engine revolutions</li> <li>2. Too high water pressure</li> </ol>	<ol style="list-style-type: none"> <li>1. Modify the position of the speed lever, check the position of the locating screw of the speed lever</li> <li>2. Cut down the output pressure of the water with the control on the pump according to the instruction on the page 8.</li> </ol>
The engine stopped during the operation	<ol style="list-style-type: none"> <li>1. The engine consumed the fuel</li> <li>2. The spark plug fell out.</li> <li>3. Low oil level in the engine</li> <li>4. Low water level in the tank</li> <li>5. High vacuum in the suction pipes</li> <li>6. High water temperature in the pump</li> </ol>	<ol style="list-style-type: none"> <li>1.Fill the tank with the fuel</li> <li>2. Check the spark plug connector.</li> <li>3. Check the oil level in the engine</li> <li>4.Fill the water to the pump</li> <li>5. Clean the water filter</li> <li>6. Fill the cold water into the tank and let the pump cool down.</li> </ol>
The engine cannot start or it stats but runs jerky	<ol style="list-style-type: none"> <li>1. Choked air filter</li> <li>2.The engine is without fuel</li> <li>3.Old fuel</li> <li>4. The spark plug connector is not connected to the plug.</li> <li>5.The sparking plug does not work</li> <li>6. Fuel contaminated with water</li> <li>7. Wrong proportion of fuel mixture</li> <li>8. Points 4-6 in the previous column</li> </ol>	<ol style="list-style-type: none"> <li>1.Clean the air filter</li> <li>2.Fill the tank with the fuel</li> <li>3.Change the fuel for new one or fill the tank with more new fuel</li> <li>4.Check spark-plug connector</li> <li>5. Change the sparking plug for new one</li> <li>6.Discharge the fuel from the tank and carburettor, and fill in new petrol</li> <li>7. Contact the service point</li> </ol>
Engine has no power	<ol style="list-style-type: none"> <li>1. Choked air filter</li> <li>2. Old fuel</li> </ol>	<ol style="list-style-type: none"> <li>1.Clean the air filter</li> <li>1.Fill the tank with the new fuel</li> </ol>

Use only original spare parts. You will ensure non-fault conditions for the run of your device in this way.

## Guarantee

The guarantee conditions are guaranteed in every country of our distribution network. Potential failures of the appliance will be removed for free during the guarantee period if they are caused by a material or manufacturing defect. Please, contact your seller or the nearest authorized service point with the sales slip of the particular device if you apply the guarantee.

You find the list of the approved service points on our web site: [www.waspper.com](http://www.waspper.com)

The company Waspper s.r.o. try continuously to improve the technical characteristics and user comfort of their products. Because of this reason the producer reserves the right to alter the construction and controls of the device without the previous warning of the final customer. The location of all controls and security elements

illustrated in this manual is accurate and realistic. Any design change of the controls does not need to be recorded in this manual.

## Technical data

Device type	GE1065HD	GE1065BD	GE1065LD	GF1000
Engine type	Honda GX200 196cm <sup>3</sup> / 4,3kw	Briggs/Stratton XR950 208cm <sup>3</sup> / 4,7kw	Peggas G200F-L series 196cm <sup>3</sup> / 4,1kw	----
Maximal speed	3600 rpm	3600 rpm	3600 rpm	----
Engine type	Four-stroke OHV	Four-stroke OHV	Four-stroke OHV	----
Torque	12,4 Nm/ 2600 rpm	12,9 Nm/ 2600 rpm	12,4 Nm/ 2500 rpm	----
Sparking plug	Brisk: LR15YC 0,7-0,8mm	Brisk: DR17YC 0,7-0,8mm	Brisk: LR14YC 0,7-0,8mm	----
	Champion: RN7YC	Champion: QC12YC	Champion: RN7YC	
	NGK: BPR6ES	NGK: BKR5ES	NGK: BPR7ES	
Tank capacity	3,1L	3,1L	3,6L	1000L- water
Capacity of the oil filler	0,6L / 10w40	0,6L / 5w30	0,6L / 10w40	----
Water pressure and flow	3200psi/ 220bar 14L/ min	3200psi/ 220bar 14L/ min	3200psi/ 220bar 14L/ min	----
Net weight	30 kg	30 kg	30 kg	135 kg
Height	64 cm	64 cm	64 cm	115 cm
Width	101 cm	101 cm	101 cm	110 cm
Length	47 cm	47 cm	47 cm	190 cm
Self-priming function of water	Yes	Yes	Yes	----
Fuel consumption	1,7L/ hour	1,98L/ hour	2,1L/ hour	----
Volume of detergent bottle	----	----	----	15L

## Components list



- Water tank
- Water level indicator
- Pressure gun
- Hose reel drum
- Engine
- Tank frame
- Nozzles holder and area for accumulator
- Handling hole for Forklift



## EU Declaration of Conformity

The company Waspper s.r.o. hereby declares that the water pumps defined below comply with the relevant EU directives on occupational health and safety of the device operators. Any alteration of the device without the prior consent from the manufacturer will render this declaration void.

Product name: High pressure washer

Type	Serial number	ES inspection report	Noise level measured	Guaranteed noise level
GE1065HD	xx0001001-xx9999999	1802/3/2019-02	97 dB	99 dB
GE1065BD				
GE1065LD				
GF1000	xx0001001-xx9999999	1802/3/2019-01	-	-

Protokol o skúške 29032019 zo dňa 29.03.2019

Certificate issued by: TECHNICKÁ INŠPEKCIA a.s., pracovisko KOŠICE, as an accredited inspection body in accordance with EN ISO / IEC 17020

**Applicable EU Directives:**  
2006/42/ES (+2009/127/ES)  
2004/108/ES  
2000/14/ES

**Standards applied:**

STN EN ISO/IEC 17 020

Producer:

Waspper s.r.o, Duklianska 51, 05201 Spišská Nová Ves, Slovensko

Issued in: Spišská Nová Ves

Manufacturer's representative: Marián Garbriš

Issue date: 25.9.2019

Position: Managing Director

# Warranty Certificate

Product type:	<b>WASPPER</b>	Stamp and signature:
Serial number:	Date of purchase:	

In pursuit of service enhancement and simplification of communication with customers, the company Waspper s.r.o. recommends its customers, who purchase this product, to register their product via the manufacturer's website: [www.waspper.com](http://www.waspper.com). This registration will provide inevitable data for faster processing of your complaints or consulting relevant to purchasing of spare parts and accessories. This registration enables the customer to avoid further procedures, as submitting of the purchase receipt or the warranty certificate.

1. The manufacturer - Waspper s.r.o. - is liable for inherent defects of the product purchased, if such defects become evident within the warranty period. Application of claims for repairs under warranty requires completion and submission of the complaint form via the manufacturer's website: [www.waspper.com](http://www.waspper.com). The product is covered by a full warranty of 24 months for private customers (as defined by the Civil Code) and 12 months for corporate customers (as defined by the Commercial Code). The warranty period commences upon completion and submission of the complaint report via the website in case of simple defects and damages. The commencement of warranty in case of major defects starts upon the product delivery to the manufacturer's address: Waspper s.r.o., Duklianska 51, 05201 Spišská Nová Ves. Acceptance of complaint will be notified to the customer using the contact details entered in the complaint form.

2. The warranty does not cover defects incurred due to: wrong operation; improper handling or use contradictory to the operation manual or instructions and recommendations from the company Waspper s.r.o; use or storage of goods within inappropriate areas, especially with respect to temperature, dust formation or ambient humidity; exposure to direct sunlight; damage attributable to natural disasters of force majeure. The warranty does not apply to mechanical damages, any damages due of solid particles, frost or other weather effects. The warranty does not apply to damage to the pump caused by cavitation. Other exemptions from warranty include damages to the engine due to lack of oil and ingress of any other but operating fluid among internal engine components.

3. Particular steps of claims processing will be notified to the customer following assessment of the scope of repair by the claims engineer. Whenever the replacement of a damaged component can be performed by the customer, the latter will receive a relevant spare part only. If the repair by a servicing centre is inevitable, the customer is obliged to mail the damaged device to the manufacturer's address. The device must be complete (including accessories) and packed properly to prevent its damage during transport, it must be free of mechanical damage and contain no operating fluids. If the goods submitted to the servicing centre shows evident signs of damage or excessive wear, the manufacturer reserves the right to reject such consignment without acceptance.

4. Claims for repairs under warranty oblige the customer to provide the receipt of purchase (invoice, cash receipt) together with the warranty certificate and written description in support of their claim, including photographic documentation. It is recommended to complete the complaint form via the manufacturer's website to ensure the fastest processing of the claim as possible, if the manufacturer acknowledges such claim as justified, the repaired item will be sent to the customer and the postage/freight will be covered by the manufacturer.

5. If the claims engineer finds out the product does not comply qualifications for repair under warranty, the claim will be considered unjustified and the costs of product transport to the customer will be paid by the latter.

6. Should the repair period exceed 30 days or if the product is irreparable, the customer will be offered a replacement item.

7. Justification of claims will be assessed by the claims engineer at the manufacturer. Justified claims will extend the warranty period by the period taken by the claim processing period. Such action will be confirmed to the customer by means of a document in writing, dispatched together with the product or sent via e-mail. If the product subject to claim contains any discontinued component, the manufacturer will provide the customer with an adequate replacement item with its parameters corresponding with the returned product or even better.

8. The customer undertakes to read all the information found on the packaging or in the operation manual; to do so immediately following the product delivery, to acknowledge that preservation of the positive characteristics of the product delivered will be subject to its proper operation and storage. Any disregard to obligations defined herein relieve the company WPW Center s.r.o. from any liability for defects of goods or damages incurred due to breach of this obligation by the customer or any other third party. The customer is obliged to check the intact condition of packaging and product during the purchase and takeover of the consignment from the postman. Any damage to the packaging must be reported to the carrier and recorded immediately. Any damages found only after unpacking of the product must be notified to the distributor within the maximum period of 4 working days. No later claims for product damage can be accepted.

